



HIGHLIFE® COLLECTION

GRANDEE™ | ENVOY™ | VANGUARD™ | ARIA™ | SOVEREIGN™ | TRIUMPH™
PRODIGY™ | JETSETTER™ LX | JETSETTER™

OWNER'S MANUAL 50HZ



HotSpring®

Every day made better®



HotSpring[®]
Every day made better[®]

Highlife[®] **Collection**

**WATKINS WELLNESS congratulates you on your decision to enjoy the finest spa available...
 Welcome to the growing family of HOT SPRING spa owners.**

Before you begin reviewing the manual, please take a moment to register your warranty. Doing so will assist us in contacting you for any important product notification.

Prior to registering, you will need the serial number that is located within the equipment compartment of your **HOT SPRING** spa.

To register please go to <http://www.hotspring.com/hot-tub-owners/hot-tub-product-warranty-registration> or simply scan the QR code below:

FOR YOUR RECORDS



Spa Model/Serial Number: _____

Date Purchased: _____

Dealer: _____

Address: _____

Cover Serial Number: _____

Accessory Serial Number: _____

If you have any questions about any aspect of your spa's set-up, operation or maintenance, contact your authorized **HOT SPRING** dealership. They are trained professionals who are familiar with the product as well as new spa ownership concerns. Their expertise will facilitate the enjoyment of your new **HOT SPRING** spa.

IMPORTANT: WATKINS WELLNESS reserves the right to change specifications, or design, without notification and without incurring any obligation.



In most cities and counties, permits will be required for the installation of electrical circuits or the construction of exterior surfaces (decks and gazebos). In addition, some communities have adopted residential barrier codes which may require fencing and/or self-closing gates on the property to prevent unsupervised access to a pool (or spa) by children under 5 years of age. Your **HOT SPRING** spa is equipped with a locking cover that meets the ASTM F1346-91 Standard for Safety Covers and as a result, is usually exempt from most barrier requirements. As a general practice, your local Building Department will inform you of any applicable barrier requirements at the time a permit is obtained for the installation of an electrical circuit. Your **HOT SPRING** dealer can provide information on which permits may be required.

TABLE OF CONTENTS

SAFETY INFORMATION

IMPORTANT SAFETY INSTRUCTIONS	1
IMPORTANT SPA INSTRUCTIONS	3

GETTING STARTED

SPA FEATURES	4
QUICK START-UP INSTRUCTIONS	5
EQUIPMENT COMPARTMENT DOOR	7
EQUIPMENT COMPARTMENT	7

WATER QUALITY AND MAINTENANCE

BASIC INFORMATION	8
CHEMICAL SAFETY	8
HOW TO ADD CHEMICALS TO THE WATER	8
FUNDAMENTALS OF WATER MAINTENANCE	9
THE HOT SPRING SPA WATER MAINTENANCE PROGRAM	10
VANISHING ACT INSTRUCTIONS	11
VACATION WATER CARE INSTRUCTIONS	12
WATER TERMINOLOGY	13

OPERATING INSTRUCTIONS

WIRELESS REMOTE CONTROL	14
HOME SCREEN	14
TEMPERATURE CONTROL	15
MEMORY SCREEN	15
CLEAN CYCLE SCREEN	15
SETTINGS SCREENS	15
JETS CONTROL SCREEN	17
SALT SYSTEM SCREEN (OPTIONAL)	17
MUSIC SYSTEM SCREEN (OPTIONAL)	17
LIGHTS CONTROL SCREEN	18
DOCKING TRAY FUNCTION BUTTONS	18

JET MENU

GRANDEE™ (MODEL GGNE)	19
ENVOY™ (MODEL KKNE)	20
VANGUARD™ (MODEL VVNE)	21
ARIA™ (MODEL ARNE)	22
SOVEREIGN™ (MODEL IINE)	23
TRIUMPH™ (MODEL TRHNE)	24
PRODIGY™ (MODEL HNE)	25
JETSETTER™ LX (MODEL JTNE)	26
JETSETTER (MODEL JJNE)	27

SPA CARE AND MAINTENANCE

DRAIN & REFILL INSTRUCTIONS	28
PREVENTION OF FREEZING	28
FILTER SYSTEM	29
FILTER CARTRIDGES REMOVAL & CLEANING	29
CARE OF THE SPA PILLOWS	29
CARE OF THE EXTERIOR	30
CARE OF THE SPA COVER	30
COVER LIFTER SYSTEM	31

ELECTRICAL REQUIREMENTS

INSTALLATION	32
--------------------	----

INSTALLATION INSTRUCTIONS

SITE PREPARATION	33
OUTDOOR AND PATIO INSTALLATION	33
DECK INSTALLATION	33
INDOOR/BASEMENT INSTALLATION	33
SPA LEVELING PREPARATION	33
SPA LEVELING INSTRUCTIONS	34
DELIVERY ACCESS	34
GROUND PREPARATION	35
GRANDEE	36
ENVOY	37
VANGUARD	38
ARIA	39
SOVEREIGN	40
TRIUMPH	41
PRODIGY	42
JETSETTER LX & JETSETTER	43

SERVICE INFORMATION

GENERAL INFORMATION	44
RCD AND HIGH LIMIT THERMOSTAT	44
NO-FAULT™ HEATER AND INTEGRATED PRESSURE SWITCH	44
SILENT FLO™ CIRCULATION PUMP AND CIRCULATION PUMP THERMAL CUT-OFF	44
MISCELLANEOUS SERVICE INFORMATION	44
ACTS INVALIDATING WARRANTY	45
CUSTOMER SERVICE	45
TROUBLESHOOTING	45
DOOR PANEL REMOVAL	47
SPA SPECIFICATIONS	48

SAFETY INFORMATION

IMPORTANT SAFETY INSTRUCTIONS

(READ AND FOLLOW ALL INSTRUCTIONS)

AVOIDING THE RISK TO CHILDREN

DANGER - RISK OF CHILD DROWNING

Extreme caution must be exercised to prevent unauthorized access by children. To avoid accidents, ensure that children cannot use a spa unless they are supervised at all times.

WARNING

To reduce the risk of injury, do not permit children to use this spa unless they are closely supervised at all times.

- To reduce the risk of injury, lower water temperatures are recommended for young children. Children are especially sensitive to hot water.
- The device should not be used by persons (including children) with reduced physical, sensory or mental capabilities, or lack of experience and knowledge, unless they receive supervision or training.
- Extreme caution must be exercised to prevent unauthorized access by children. To avoid accidents, ensure that children cannot use a spa unless they are supervised at all times.

DO:

- Make sure you always lock the child resistant locks after using the spa for your children's safety. Every **HOT SPRING** spa is equipped with a locking cover that meets the ASTM F1346-91 Standard for Safety Covers.
- Test the water temperature with your hand before allowing children to enter the spa to be sure that it's comfortable. Children are especially sensitive to hot water.
- Remind children that wet surfaces can be very slippery. Make sure that children are careful when entering or exiting the spa.

DON'T:

- Allow children to climb onto the spa cover.
- Allow children to have unsupervised access to the spa.

AVOIDING THE RISK OF ELECTROCUTION

DANGER - RISK OF ELECTROCUTION

- Connect only to a grounded source.
- Do not bury the power cord. A buried power cord may result in death, or serious personal injury due to electrocution if direct burial-type cable is not used, or if improper digging occurs.

- A ground terminal (pressure wire connector) is provided on the control box inside the unit to permit connection of a minimum 6 mm² solid copper bonding conductor between this point and any metal equipment, metal water pipe, metal enclosures of electrical equipment, or conduit within 1.5 m (5') of the unit as needed to comply with local requirements.
- Do not operate the main audio/video button controls on any external media devices such as a CD or DVD player while inside in the spa. Operation of integrated audio/video equipment through the spa control panel or wireless remote is permitted and acceptable.
- Do not connect any auxiliary components (for example, cable additional speakers, headphones, additional audio components) to the audio system unless approved by **WATKINS WELLNESS**.
- Do not self service audio component by opening spa door as this may expose dangerous voltage or other risk of injury. Refer all servicing to qualified service personnel.
- Do not attach an external antennae to a spa audio system unless installed by a licensed electrician in accordance with National Electric Code.

WARNING

- To reduce the risk of electrical shock, replace a damaged cord immediately. Failure to do so may result in death or serious personal injury due to electrocution.
- Always test the residual current device (RCD) before each use of the spa. If the RCD does not perform properly, a ground current is flowing indication the possibility of electric shock. Disconnect power to the spa until the fault has been identified and corrected.
- In order to avoid a hazard due to inadvertent resetting of the thermal cut-out, this appliance must not be supplied through an external switching device, such as a timer, or connected to a circuit that is regularly switched on and off by the utility.
NOTE: Failure to wait 30 seconds before resetting the RCD may cause the spa's Power Indicator (on the control panel) to blink. If this occurs, repeat the RCD test procedure.
- Your spa must be supplied by an RCD - with a tripping rating not exceeding 30 mA in an electrical subpanel.
- Install the spa so proper drainage is provided for the compartment containing the electrical components.

DANGER - RISK OF ELECTRICAL SHOCK

- Install at least 1.5 m (5') from all metal surfaces. A spa may be installed within 1.5 m (5') of a metal surface if each metal surface is permanently connected by a minimum 6mm² solid copper conductor attached to the wire ground connector on the terminal box that is provided.
- Do not permit any electrical appliances, such as a light, telephone, radio, or television within 1.5 m (5') of a spa. Failure to maintain a safe distance may result in death, or serious personal injury due to electrocution, if the appliance should fall into the spa.
- Do not permit any electrical appliances, such as a light, telephone, radio, or television within 1.5 m (5') of a spa. Failure to maintain a safe distance may result in death, or serious personal injury due to electrocution, if the appliance should fall into the spa.

DO:

- Be sure your spa is connected to the power supply correctly - use a licensed electrical contractor.
- Disconnect the spa from the power supply before draining the spa or servicing the electrical components.
- Test the RCD before each use.
- Replace audio components only with identical components (if your spa is equipped with an audio component).

DON'T:

- Use the spa with the equipment compartment door removed.
- Place electrical appliances within 1.5 m (5') of the spa.
- Use an extension cord to connect the spa to its power source. The cord may not be properly grounded and the connection is a shock hazard. An extension cord may cause a voltage drop, which will cause overheating of the jet pump motor and motor damage.
- Attempt to open the electrical control box. There are no user serviceable parts inside.

RISKS TO AVOID

DANGER - RISK OF INJURY

- To reduce the risk of injury to persons, DO NOT remove suction fittings (filter standpipes) located in the filter compartment.
- The suction fittings in the spa are sized to match the specific water flow created by the pump. Never replace a suction fitting with one rated less than the flow rate marked on the original suction fitting.
- There is a danger of slipping and falling. Remember that wet surfaces can be very slippery. Take care when entering or exiting the spa.
- Never operate spa if the suction fittings are broken or missing.
- People with infectious diseases should not use the spa.
- Keep any loose articles of clothing, long hair, or hanging jewelry away from rotating jets or other moving components.

INCREASED SIDE EFFECTS OF MEDICATION

- The use of drugs, alcohol may cause unconsciousness with the possibility of drowning.
- Persons using medications should consult a physician before using a spa; some medication may cause a user to become drowsy, while other medication may affect heart rate, blood pressure, and circulation.
- Persons taking medications which induce drowsiness, such as tranquilizers, antihistamines, or anticoagulants should not use the spa.

HEALTH PROBLEMS AFFECTED BY SPA USE

- Pregnant women should consult a physician before using spa.
- Persons suffering from obesity, or with a medical history of heart disease, low or high blood pressure, circulatory system problems, or diabetes should consult a physician before using spa.

UNCLEAN WATER

- Keep the water clean and sanitized with correct chemical care. The recommended levels for your **HOT SPRING** spa are:

Free Available Chlorine: 1.0-5.0 ppm	Total Alkalinity: 40-120 ppm
Water pH: 7.2-7.8	Calcium Hardness: Standard 75-150 ppm Salt System 25-75 ppm

- Refer to Water Quality and Maintenance section for complete instructions.

IMPORTANT: Turn on the jet pump for a least ten minutes after adding ANY spa water chemicals into the filter compartment.

Clean the filter cartridges monthly to remove debris and mineral buildup which may affect the performance of the hydromassage jets, limit the flow, or trip the high limit thermostat, which will turn off the entire spa.

AVOIDING THE RISK OF HYPERTHERMIA

Prolonged immersion in hot water can result in HYPERTHERMIA, a dangerous condition which occurs when the internal temperature of the body reaches a level above normal 37°C (98.6°F). The symptoms of hyperthermia include unawareness of impending hazard, failure to perceive heat, failure to recognize the need to exit the spa, physical inability to exit the spa, fetal damage in pregnant women, and unconsciousness resulting in a danger of drowning.

WARNING

The use of alcohol, drugs, or medication can greatly increase the risk of fatal hyperthermia in hot tubs and spas.

TO REDUCE THE RISK OF INJURY

- The water in the spa should never exceed 40°C (104°F). Water temperatures between 38°C and 40°C (100°F and 104°F) are considered safe for a healthy adult. Lower water temperatures are recommended for extended use (exceeding ten minutes) and for young children. Extended use can cause hyperthermia.
- Pregnant or possibly pregnant women should limit spa water temperatures to 38°C (100°F). Failure to do so may result in permanent injury to your baby.
- Do not use spa immediately following strenuous exercise.

AVOIDING THE RISK OF SKIN BURNS

- To reduce the risk of injury, before entering a spa the user should measure the water temperature with an accurate thermometer.
- Test the water with your hand before entering the spa to be sure it's comfortable.

SAFETY SIGN

Each **HOT SPRING** spa is shipped with a SAFETY SIGN in the owner's package. The sign, which is required as a condition of Product Listing, should be permanently installed where it is visible to the users of the spa. To obtain additional SAFETY SIGNS, contact your **HOT SPRING** dealer and request Part #70798.

IMPORTANT SPA INSTRUCTIONS

The following contains important spa information, and we strongly encourage you to read and apply them.

DO:

- Use and lock the vinyl cover when the spa is not in use, whether it is empty or full.
- Follow the Spa Care and Maintenance recommendations stated in this manual.
- Use only approved accessories and recommended spa chemicals and cleaners.
- Provide adequate drainage to deal with overflow water.

DON'T:

- Leave the **HOT SPRING** spa exposed to the sun without water or the cover in place. Exposure to direct sunlight can cause solar distress of the shell material.
- Roll or slide the spa on its side. This will damage the siding.
- Lift or drag the vinyl cover by using the cover lock straps; always lift or carry the cover by using the handles.
- Attempt to open the electrical control box. There are no user serviceable parts inside. Opening of the control box by the spa owner will void the warranty. If you have an operational problem, carefully go through the steps outlined in the Troubleshooting section. If you are not able to resolve the problem, contact your authorized **HOT SPRING** dealer. Many problems can easily be diagnosed over the telephone by an Authorized Service Technician.

SPA SHELL

Your **HOT SPRING** spa has an acrylic shell. Stains and dirt generally will not adhere to your spa's surface. A soft rag should easily remove most dirt. Most household chemicals are harmful to your spa's shell (see below for detailed information on cleaning agents). Always rinse off any spa shell cleaning agent with fresh water.

IMPORTANT:

1. The following products are the **ONLY** approved cleaning agents for your **HOT SPRING** spa shell: plain water, **HOT SPRING** FreshWater™ Spa Shine, or Soft Scrub®. The use of alcohol or any other household cleaner other than those listed to clean the spa shell surface is **NOT** recommended. **DO NOT** use any cleaning products containing abrasives or solvents since they may damage the shell surface, specifically: Simple Green®, Windex® or Spa Mitt. **NEVER USE HARSH CHEMICALS!** Damage to the shell by use of harsh chemicals is not covered under the warranty. Always rinse off any spa shell cleaning agent with fresh water.
2. Iron and copper in the water can stain the spa shell if allowed to go unchecked. Ask your **HOT SPRING** dealer about a Stain and Scale Inhibitor to use if your spa has a high concentration of dissolved minerals. Watkins recommends **FRESHWATER** Stain & Scale Defense.
3. Keep all cleaners out of the reach of children and use care when applying.

SAVE THESE INSTRUCTIONS

GETTING STARTED

SPA FEATURES

(Your spa may look different)



1) Remote control panel can be removed from the spa and used as a remote inside or outside the spa.



2) The **SmartJet™** system lets you divert water to different combinations of jets simply by turning the lever.



3) The **Comfort Control™** lever lets you dial in the ideal amount of air for both the Precision™ and Moto-Massage™ DX Jets.



4) The **Water Feature Lever** adjusts the amount of water that flows from the either one of the two available water features.



5) The **Hydromassage** jet with directional nozzle provides maximum performance.



6) The **Hydromassage** jet with dual port rotary nozzle provides a V-shaped, pulsating massage.



7) The **SoothingStream™** Jet has twelve nozzles that provides treatment to your shoulders and upper back.



8) The **FootStream™** jet provides a maximum-strength massage with an invigorating, directional whirlpool jet.



9) The **HydroStream™** jet has a strong flow of water and air which quickly soothes away tension.



10) The **PRECISION** directional or rotary jet delivers a therapeutic massage.



11) The **MOTO-MASSAGE DX** is a moving jet. It has two warm streams of water sweeping up and down the entire length of your back.



12) The **Luminescence™ Multi-Color Four-Zone Lighting** system, you can individually control each zone- underwater, bartop, pillows and water features. The light shown is used underwater.



13) The **BellaFontana™** water feature creates three arcs of dancing water.



14) **FRESHWATER** salt system housing cap.



15) **Pillow** - Most spas come with one or more pillows.



16) **Spa Filter** provides 100% No-Bypass filtration, all water passes through the filter before it re-enters the spa (not illustrated).



17) This is the **Heater Return and Spa Drain**. Ozone bubbles from the ozone system can also be seen coming from the drain.



18) The spa is entertainment-ready for easy speaker installation. This cap can be removed and replaced with a speaker.



19) The **HOT SPRING logo** on the front of the spa illuminates a blue and green color. These colors indicate the power and ready status of the spa without having to open the cover to look at the control panel (not illustrated).



20) The **Docking Station** charges the remote control. It also receives wireless communication from the remote and can be used to turn the Jets and Lights On and Off (not illustrated below #1).

21) Convenience tray is available as a secondary placement location for the wireless remote control panel. Remote will NOT charge in this location.

MOTO-MASSAGE DX JET

The **MOTO-MASSAGE DX** jet automatically travels up and down in a sweeping motion, simulating the natural stroking effects of a manual massage. The intensity of the **MOTO-MASSAGE DX** jet may be adjusted by turning the **COMFORT CONTROL** lever.

The **MOTO-MASSAGE DX** jet has been factory adjusted to provide maximum hydromassage, and to achieve full vertical travel with its **COMFORT CONTROL** lever in the full air volume position. Should the **MOTO-MASSAGE DX** jet not achieve full vertical travel and the problem is not a closed air control valve or clogged filter cartridge, then your **HOT SPRING** Service Center should be contacted.

IMPORTANT: A slow or non-moving **MOTO-MASSAGE DX** jet may indicate that the filter cartridge pores are obstructed with dirt, body oils, or calcification. Follow the filter cartridge cleaning procedures in the Spa Care and Maintenance section of this manual.

HYDROMASSAGE JETS

The Hydromassage jets have two different nozzle options: directional and dual port rotary. The directional nozzle allows you to aim the water in the direction that feels best. The dual port rotary nozzle divides the water flow into two streams, and then spins.

Turn the faceplate to increase and decrease the jet pressure.

ACCESSORY NOTE: Your **HOT SPRING** dealer stocks hydromassage jet kits which can easily be installed in your spa to modify your jets from directional to dual port rotary.

SOOTHINGSTREAM JET

The **SOOTHINGSTREAM** jet is another unique feature of **HOT SPRING** spas. Its seven outlets are designed to massage the muscles in the upper back and shoulders, gently and thoroughly. Turn the faceplate clockwise to increase the jet pressure and counterclockwise to decrease the jet pressure. Turn the faceplate to increase and decrease the jet pressure.

PRECISION DIRECTIONAL OR ROTARY JETS

PRECISION jets are located above **MOTO-MASSAGE DX** jets and in groups of various sizes. They are designed to perform a soft, soothing massage on your back and shoulders. Adjust the pressure of the **PRECISION** jets using the **COMFORT CONTROL** lever (located closest to the **PRECISION** jets).

Refer to the drawings on the following pages to familiarize yourself with the **SMARTJET** system menus for your spa. Please note that the **SMARTJET** lever side of the spa is always considered the front when referring to the locations of the different types of jets and jet systems.

The clock positions are correct when facing the spa, standing at the SMARTJET lever.

FOOTSTREAM JET

The **FOOTSTREAM** jet is a large orifice hydromassage jet designed to put maximum massaging action on a specific area of the body. It is located in the lower part of the spa to afford optimal access for the massaging of feet, legs, hips, and lower back. The intensity of the **FOOTSTREAM** jets can be altered (except the ones found in the FootWell™ system) using the **COMFORT CONTROL** lever. **FOOTSTREAM** jets located in the **FOOTWELL** are not adjustable. Turn the faceplate to increase and decrease the jet pressure.

HYDROSTREAM JET

The **HYDROSTREAM** jet is a mid-size hydromassage jet that delivers a great massage to the feet, back and shoulder areas. Turn the faceplate to increase and decrease the jet pressure.

WATER FEATURE

GRANDEE, ENVOY, VANGUARD & ARIA spas are equipped with a **BELLAFONTANA** water feature. This water feature can be turned on or off when the two-speed pump is on low speed (tranquil mode) or high speed. To function correctly, the water feature on/off lever must be placed in the *full on* position only.

If the lever is not in the *full on* position when the pump is on high speed, it is likely that the water feature will project water substantially farther out into the spa as the on/off lever is opened. This is not proper operation. If this occurs, the pump should be turned off, the water feature lever rotated to the full on position and the pump turned on again.

CAUTION: Partial blockage of water flow at entrance of water feature will cause the water to flow farther into or over the spa.

HOT SPRING LOGO LIGHT

The **HOT SPRING** logo on the front of the spa illuminates a blue and green color. These colors indicate the power and ready status of the spa without having to open the cover to look at the control panel.



Green Indicator: The GREEN indicator will light when the spa water temperature is within 1°C (2°F) of the set temperature, and will turn off when the temperature is outside of that range. If you increase or decrease the temperature setting of the spa, the ready indicator will turn off until the water temperature reaches the acceptable range for the new temperature setting. A flashing GREEN indicator means a problem may exist with the temperature sensor. A one second on and 3 second off flashing GREEN indicator means there is an issue with the salt system (see Troubleshooting section for more information).

Blue Indicator: The BLUE indicator is 'on' when the spa is properly supplied with power. It also provides a diagnostic function—a flashing BLUE indicator indicates that the heater high limit has tripped, meaning that either the spa water is above its acceptable temperature range, or a malfunction has occurred within the spa (such as low circulation due to clogged filters). An 'off' BLUE indicator means that there is a problem with the spa control box or the power supplied to the spa (see Troubleshooting section for more information).

QUICK START-UP INSTRUCTIONS

BEFORE YOU FILL YOUR SPA

Make sure your spa has been properly installed per all local codes, this includes the location of the spa, the foundation of the spa as well as the electrical installation of the spa. Installation instructions in the form of a Pre-Delivery Instruction booklet can be obtained from either your **HOT SPRING** dealer or online at:

www.HotSpring.com/planning-tools/pre-delivery-instructions

DO:

- Know which water treatment system you will be using and make sure you have necessary chemicals available. Read all of the instructions that come with the system.
- Have **FRESHWATER** 5-way Test Strips Available.

- Have pH/Alkalinity Up & Down available.
- Know the "Hardness" of your water, contact your dealer to help you with this information. See Water Quality and Maintenance for more information.
IMPORTANT: WATKINS WELLNESS does not recommend that the spa be filled with "softened" water, as this may damage the spa's equipment.
- Purchase the Clean Screen™ pre-filter to remove unwanted contaminants from the tap water. This is recommended, not required.

DON'T:

- Power up the spa until it has been filled with water! Power to the spa automatically activates critical components within the spa, such as controls, heater, circulation pump, and other systems. If power is supplied to these components prior to the spa being filled, the components will be damaged, and this may result in a non-warranty component failure.

DON'T:

- Fill the spa with hot water or cold water with cold water temperature below 10° C! Tripping of the high-limit thermostat may result causing your spa to stop functioning.

DON'T:

- Use your spa after filling until all of the steps listed below START-UP are completed!
- Add chlorine if treating your spa with polyhexamethylene biguanide (Biguanide, PHMB, eg. BaquaSpa®) sanitizer.

START-UP

Your **HOT SPRING** spa has been thoroughly tested during the manufacturing process to ensure reliability and long-term customer satisfaction. A small amount of water may have remained in the plumbing after testing and, as a result, may have spotted the spa shell or the spa siding prior to delivery. Before filling the spa, wipe the spa shell clean with a soft rag.



The following instructions must be read and followed exactly to ensure a successful start-up or refill.

1. **CLOSE ALL DRAINS AND FILL THE SPA** with water through the filter compartment. Your **HOT SPRING** spa water level should be maintained approximately 4 cm above the top of the highest jet.
2. **AFTER THE SPA HAS BEEN FILLED** with water and the equipment compartment door is secured, power must be applied to the spa.
3. **TO CHECK THE OPERATION OF THE JET SYSTEM** and to purge any remaining air from the heating system:
 - Push the JETS icon on the Home Screen.
 - Push the double jet icons to run the jet pumps on high speed for one minute.
 - Press the OFF icon (far right) once the jet system is full operational (as indicated by strong, non-surgingly jets), priming of the spa is complete, to shut the jets off.

Weak or surging jets are an indication of a low water level condition or clogged filter cartridges.

IMPORTANT: Be sure the **COMFORT CONTROL** Levers (see illustration in Spa Features section) are open by turning each one clockwise and checking to see that the **SMARTJET** lever is pointing

in the  position.

4. **USING A TEST STRIP AND APPLICABLE CHEMICALS**, adjust Total Alkalinity (TA) to 80 ppm, Calcium Hardness (CH) to 100 ppm (if using a Salt System 50 ppm), then spa water pH to between 7.2 and 7.8. These procedures are listed in the "Water Quality and Maintenance" section.
IMPORTANT: Always add spa water chemicals directly into the filter compartment with the jet pump on high speed for at least ten minutes. Adjusting the Total Alkalinity (TA) as the first step is important, as out-of-balance TA will affect your ability to adjust the pH correctly and will prevent the sanitizer from operating effectively.
5. **SUPERCHLORINATE THE SPA WATER** by adding 1½ teaspoons of chlorine (sodium dichlor) per 950 liters of spa water. Press the Clean Cycle icon on Home screen to circulate the spa water for a ten-minute period.
6. **DURING THE SUPER-CHLORINATION PERIOD**, rotate the **SMARTJET** lever(s) through both operating positions, letting the spa water circulate (with jets on) for equal periods of time. The **HOT SPRING** spa's **SMARTJET** levers are designed to operate in the 3 o'clock and 9 o'clock positions.
7. **SET THE TEMPERATURE CONTROL**, the spa is pre-programmed to reach 38°C (100°F), and will normally do so within 18 to 24 hours. You may raise the water temperature by:
 - Press the temperature window in the Home screen to display the Set Temperature Screen.
 - Press  or  to change the water set temperature.

Place the vinyl cover on the spa and allow the water temperature to stabilize. Make sure you secure the cover in place using the cover locks. Periodically check the spa water temperature. When the water temperature climbs above 32°C (90°F), proceed to the next step.
To prevent tampering, you can lock your desired temperature setting. Refer to the Main Control Panel section for details.
8. **ROTATE THE SMARTJET SYSTEM LEVER(S) TO THE PRIMARY POSITION (3 O'CLOCK)** Activate the clean cycle as described in step 5 to turn on the CLEAN cycle for ten minutes to circulate the spa water. After the clean cycle is complete, test the spa water for Free Available Chlorine (FAC) residual. If the residual is between 3-5 ppm on the test strips (between 1-5 ppm if using a salt system) go on to the next step. If the residual is less than 3 ppm, superchlorinate the spa water by adding 1½ teaspoons of chlorine (sodium dichlor) per 950 liters (250 gallons) of spa water. Activate the clean cycle again to circulate the spa water for another ten-minute period.
9. **ROTATE THE SMARTJET SYSTEM LEVER(S) TO 2ND POSITION (9 O'CLOCK)** Activate the clean cycle as described in step 5 to turn on the cycle for ten minutes to circulate the spa water. Test the spa water for Free Available Chlorine (FAC) residual. If the residual is between 3-5 ppm on the test strips (between 1-5 ppm if using a salt system) go on to the next step. If the residual is less than 3 ppm, superchlorinate the spa water by adding 1½ teaspoons of chlorine (sodium dichlor) per 950 liters (250 gallons) of spa water. Activate the clean cycle again to circulate the spa water for another ten-minute period. Repeat this procedure until both **SMARTJET** lever(s) operating positions have been tested.

10. RECHECK the Total Alkalinity (TA) at 80 ppm, Calcium Hardness (CH) at 100 ppm (if using a Salt System 50 ppm), then spa water pH at between 7.2 and 7.8. using a **FRESHWATER** 5-way test strip.
IMPORTANT: Make sure you adjust your Total Alkalinity first, as an out-of-balance condition will affect your ability to adjust the pH correctly, and will prevent the sanitizer from operating effectively.
The spa is ready for use when the spa water has circulated through each SMARTJET lever operating position and the chlorine level remains between 3 ppm and 5 ppm (between 1-5 ppm if using the a Salt System).

11. TEST WATER WEEKLY OR BEFORE EACH TIME THE SPA IS USED.

GETTING STARTED

EQUIPMENT COMPARTMENT DOOR

The equipment compartment door is located below the dock. To remove door, slide each of the 3 clips to the left and lower clip (if clip doesn't slide, slightly loosen the 2 screws holding the clip). Lower door panel, remove connector from back side of door attached to the Logo light, remove door panel. Reverse procedure to reattach door panel.

IMPORTANT: Make sure top right side of Logo Light is seated inside spa corner cutout when replacing the door.

EQUIPMENT COMPARTMENT

The illustration below is to be used as a reference only (your spa may look different). The equipment compartment is located behind the front panel of the spa below the dock.

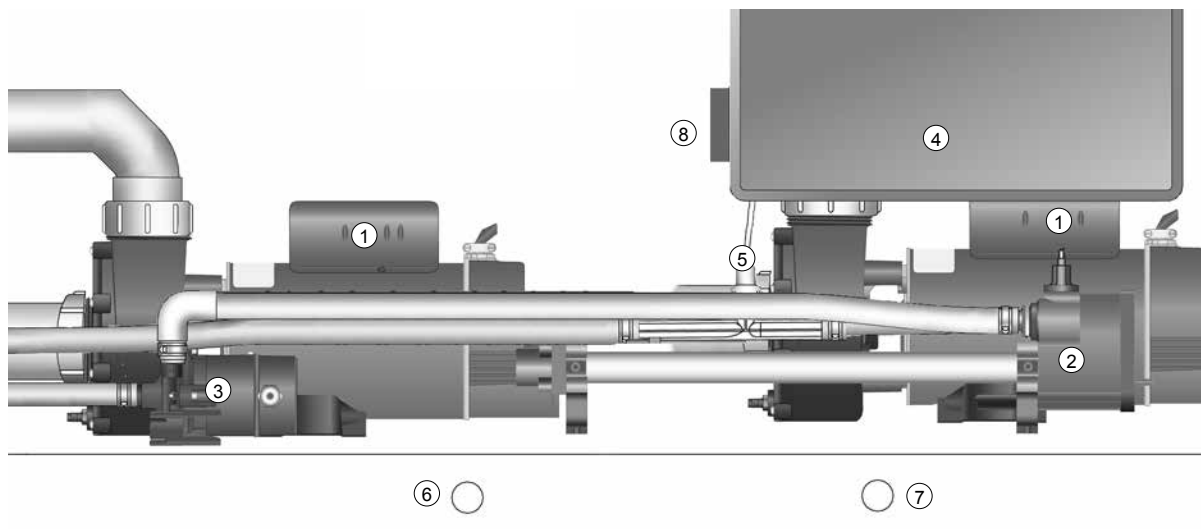

EQUIPMENT COMPARTMENT

- | | |
|--------------------------------------|-------------------------------------|
| 1. Wavemaster™ jet pump | 5. Ozone injector (optional) |
| 2. No-Fault™ heater | 6. Main drain (with shut-off valve) |
| 3. Silent Flo 5000™ circulation pump | 7. Secondary drain |
| 4. IQ 2020™ control box | 8. Bonding terminal |

WATER QUALITY AND MAINTENANCE

BASIC INFORMATION

It's important to have clean water. Water maintenance is one of the least understood, yet most important, areas of spa ownership. Your dealer can guide you through the process of achieving and maintaining balanced water in your spa, given your local conditions.

IMPORTANT: Water Terminology can be found at the end of this section.

- **Always read and refer to the owner's manual** for complete information.
- **Test your water** with a test strip once a week, or each time the spa is used.
- **Add chemicals** in frequent small amounts to prevent overdosing the spa.
- **Use the spa only** when the chlorine level is between 1-5 ppm or manually add chlorine as needed.
- **When using a Salt System**, read and refer to separate owner's manual.
- **It is the spa owner's responsibility** to prevent over or under chlorination.

IMPORTANT: Remember to change your water every three to four months (longer for salt). Spa water that is maintained using a Salt Sanitizing System may last much longer - up to twelve months, with proper care*. Refer to the owner's manual for detailed instructions.

Check with your **HOT SPRING** dealer to determine if water in your region has unique qualities - such as high metal or mineral content - that should be addressed.

Your program will depend on your water's mineral content, how often you use your spa, and how many people use it.

WATER QUALITY CHART

PARAMETER	TARGET	MIN - "OK" RANGE - MAX	
pH	7.4	7.2	7.8
ALKALINITY	80 ppm	40 ppm	120 ppm
HARDNESS	100 ppm	75 ppm	150 ppm
HARDNESS (SALT SYSTEM)	50 ppm	25 ppm	75 ppm
CHLORINE	3 ppm	1 ppm	5 ppm

Maintaining the water quality and the cleanliness of the filters in your spa is your responsibility. Keeping the spa water balanced prolongs the life of the spa components and will make the water more comfortable. Your dealer can guide you through the process of achieving and maintaining perfect water in your spa, given your local conditions. Your program will depend on your water's mineral content, how often you use your spa, and how many people use it. **WATKINS WELLNESS** has developed several water care systems and products to simplify water care which are available from authorized **HOT SPRING** dealers.

FRESHWATER Salt System	Vanishing Act™ Calcium Remover
FRESHWATER Salt Test Strips	CLEAN SCREEN Prefilter
FRESHWATER 5-way Test Strips	

*For more information visit www.hotspring.com/save-water

CHEMICAL SAFETY

When using chemicals, read the labels carefully and follow directions precisely. Though chemicals protect you and your spa when used correctly, they can be hazardous in concentrated form.

Always observe the following guidelines:

- Allow only a responsible person to handle spa chemicals. Keep them out of the reach of children.
- Accurately measure the exact quantities specified, never more. Do not overdose your spa.
- Handle all containers with care. Store in a cool, dry, well ventilated place.
- Always keep chemical containers closed when not in use. Replace caps on their proper containers.
- Don't inhale fumes, or allow chemicals to come in contact with your eyes, nose, or mouth. Wash your hands immediately after use.
- Follow the emergency advice on the product label in case of accidental contact, or if the chemical is swallowed. Call a doctor or the local Poison Control Center. If a doctor is needed, take the product container along with you so that the substance can be identified.
- Don't let chemicals get on surrounding surfaces or landscaping. Don't use a vacuum cleaner to clean up chemical spills.
- Never smoke around chemicals. Some fumes can be highly flammable.
- Don't store any chemicals in the spa equipment compartment.

HOW TO ADD CHEMICALS TO THE WATER

IMPORTANT: All spa water chemicals, including granulated dichlor, MPS, granulated pH increaser or decreaser, granulated total alkalinity increaser, liquid stain and scale inhibitor, and liquid defoamer must always be added directly into the filter compartment while the jet pump is running in its high speed mode, and it must run for a minimum of ten minutes.

To Administer Spa Water Chemicals:

1. Fold back the cover. Carefully remove and set aside the filter compartment cover.
2. On your Control Panel:
 - Press  on Home screen to display Clean Cycle screen.
 - Press *Start* to begin the Clean Cycle.
3. Carefully measure the recommended amount of chemical and slowly pour it into the filter compartment. Use care not to splash chemicals on your hands, in your eyes, on the spa shell surface, or on the spa cabinet.
4. Replace the filter compartment cover. After ten minutes, the jet pump will automatically shut off to complete the procedure. Close and secure the cover.

 **DANGER:** Risk of Drowning: Never leave an open spa unattended!

IMPORTANT: After administering a super chlorination treatment or non-chlorine shock to your spa, leave the cover open for a minimum of 20 minutes to allow the oxidizer gas to vent. A high concentration of trapped oxidizer gas which may exist as a result of the shock treatment (not daily sanitation) may eventually cause discoloration or vinyl degradation to the bottom of the cover. This type of damage is considered chemical abuse and is not covered under the terms of the limited warranty.

FUNDAMENTALS OF WATER MAINTENANCE

- **Testing:** Test the water weekly or each time the spa is used with convenient **FRESHWATER** 5-way test strips or more accurate liquid/tablet reagent test kit per instructions. Critical parameters: sanitizer level, pH, Calcium Hardness (CH), and Total Alkalinity (TA). Store test equipment in a dark, cool, dry place to maintain potency.
- **Water Filtration:** The 100% no by-pass 24 hour filtration used in **HOT SPRING** spas provides the best approach to keeping water clean by constantly circulating sanitizer and removing waste from the spa. Regularly inspect and clean filters for peak performance.
- **Chemical Balance/pH Control:** It is important to adjust the primary water parameters (Total Alkalinity, Calcium Hardness, pH) into the recommended ranges so that they are stabilized or balanced. Balance the water chemistry every time you fill the spa with new water and then during the life of that body of water. Keeping the water in balance prevents damage by holding the pH in a safe range and preventing calcium scale formation on spa equipment. A low pH can damage metal components whereas a high pH can cause high levels of calcium to form scale. Your dealer should provide a detailed water chemistry orientation soon after your new spa is filled for the very first time.
- The following three water components must be kept in balance to avoid damage to the spa. Do balance these components in the order they are listed here as each will help you balance the next using a minimum amount of chemicals.

ALKALINE SPA WATER (SCALING ZONE)	8.2	ADD pH DECREASER TO LOWER pH
	7.8	
COMFORT ZONE	7.6	IDEAL
	7.4	
ACIDIC SPA WATER (CORROSIVE ZONE)	7.2	ADD pH INCREASER TO RAISE pH
	6.8	
	pH	

1. Calcium Hardness (CH) – CH is the measure of the amount of dissolved calcium in the water. Low levels can make the water corrosive and high levels cause scale formation of spa components. The recommended CH reading is between **75 - 150 ppm**. A hardness of 50 ppm is recommended with the Salt System. If the CH level is too high, lower it with the **VANISHING ACT** calcium remover per instructions. Once in balance, the CH reading normally remains stable until new water is added. Great care must be taken when filling the spa from a water softener to ensure that the calcium remains in balance and avoid damage to the spa.
2. Total Alkalinity (TA) - TA is a measure of the water's ability to resist changes of pH or buffer capacity. A low TA allows the pH to fluctuate easily. The recommended TA reading is between **40 - 120 ppm**. To raise the TA, use **HOT SPRING FRESHWATER** pH/Alkalinity Up (sodium hydrogen carbonate). To lower the TA, use **HOT SPRING FRESHWATER** pH/Alkalinity Down (sodium bisulfate). Once the TA is balanced, it normally remains stable until the next drain/refill. We recommend you check the TA reading once per month. Raising/lowering the TA may cause the pH readings to fluctuate widely. Ignore the pH readings on the test strip while you are balancing the TA.
3. pH - The pH is the measure of the acidity and alkalinity. Maintaining the proper pH level will optimize the effectiveness of the sanitizer, preventing damage to the spa and physical discomfort for spa users. A low pH dissipates sanitizer, causes

corrosion, and irritates spa users. A high pH level will neutralize sanitizer, promote scaling and cloud water. The recommended pH reading is between **7.2 - 7.8**. To lower the pH level, use **HOT SPRING FRESHWATER** pH/Alkalinity Down (sodium bisulfate). To raise the pH level, use **FRESHWATER** pH/Alkalinity Up (sodium carbonate).

- **Water Conditioners:** Spa fill water varies from location to location and user to user, therefore it is important to consult with your dealer for an appropriate program.
 - a. **VANISHING ACT** – High levels of calcium and some minerals can be removed from the water with the single use **VANISHING ACT**. High calcium levels can cause scale formation on the spa equipment and shell.
 - b. **CLEAN SCREEN** pre-filter –The **CLEAN SCREEN** pre-filter should be used at every fill and top-off to remove contaminants from the fill water, especially iron, copper, and manganese. Many water sources including well water contain high concentrations of minerals that can cause staining of the shell and plastics.
 - c. Stain and Scale control – For water high in calcium and minerals, it may be necessary to use an anti-scalant like Stain and Scale control. As water evaporates from your spa and new water is added, the amount of dissolved minerals like calcium, copper, iron, and manganese will increase. (Minimize evaporation by keeping the cover on the spa whenever possible.) High iron or copper content in the water may produce green or brown stains on the spa.
 - d. Foam Inhibitors - Soap is introduced into the spa water from users' bodies and swimming apparel and can cause the spa water to foam when the jets are used. Low levels of calcium hardness (soft water) can increase foaming. Although ozone and Salt Systems can oxidize soap residual, it may become necessary to add Foam Inhibitors to suppress the foam. Excessive soap in the water may require a water change to resolve.
- **Oxidizers:** Ozone and Monopersulfate (MPS) are oxidizers used to prevent the buildup of contaminants, maximize sanitizer efficiency, minimize combined chlorine, and improve water clarity. They are to be used in conjunction with EPA registered sanitizers. The **FRESHWATER** III High Output Ozone System uses Corona Discharge technology to produce a high concentration of ozone which is injected into the spa water 24 hours per day. **HOT SPRING FRESHWATER** Chlorine-Free Oxidizer, Monopersulfate (MPS) is a granular oxidizing chemical.
- **Sanitizers:** Maintaining the recommended residual level of an EPA registered sanitizer at all times will decrease the occurrence of unsafe bacteria and viruses in your spa water. The recommended Free Available Chlorine (FAC), the amount of available chlorine sanitizer, is **3 - 5 ppm**. A low FAC can allow bacteria and viruses to grow rapidly in the warm water, and a high FAC can cause discomfort to the user's eyes, lungs, and skin. Each sanitizer carries its own instructions regarding how much to use and when to add it to the spa water. Consult your dealer for their recommendations and instructions on proper sanitizing of the spa.
 - a. **FRESHWATER** Salt System
 - b. **FRESHWATER** Concentrated Chlorinating Granules
 - c. Sodium Dichloro -Triazinetrione (sodium dichlor or chlorine)
 - d. Liquid chlorine (sodium hypochlorite)
 - e. Brominating Concentrate (one step granular bromine).
 - f. BaquaSpa® (please consult your **BAQUASPA** manual for instructions on the use of this product).

IMPORTANT: DO NOT use tri-chlor chlorine, bromo-chloro-dimethyl-hydantoin (BCDMH), or any type of compressed bromine or chlorine, acid or any type of sanitizer which is not recommended by **WATKINS WELLNESS**.

THE HOT SPRING SPA WATER MAINTENANCE PROGRAM

FILLING THE SPA WITH WATER

Use the **CLEAN SCREEN** pre-filter to remove unwanted contaminants such as rust, dirt, detergents, and algae from the fill water. Dissolved metals, copper, iron, and manganese are also removed. Instructions are included with the **CLEAN SCREEN** pre-filter. Always fill the spa through the filter compartment. Do not fill your spa using water from a swimming pool as pool chemicals are very different from those used in a spa and can damage your spa.

ADDING CHEMICALS TO THE WATER

All spa water chemicals, including granulated dichlor, MPS, granulated pH increaser or decreaser, granulated total alkalinity increaser, liquid stain and scale inhibitor, and liquid defoamer must always be added directly into the filter compartment while the jet pump is running in its high speed mode, and it must run for a minimum of ten minutes with the cover off. Use the Clean button/feature to ensure that the chemicals are properly mixed when adding.

BUILDING A SANITIZER ROUTINE

During the first month of ownership, measure the sanitizer residual daily in order to establish a baseline of sanitizer needed vs. spa usage. Sanitizer needed is the amount of FAC needed to accommodate the number of users and their combined usage time. For example, two spa users for twenty minutes every day creates regular demand on the sanitizer that is used to determine how much sanitizer to add in order to maintain the proper residual. If the usage pattern increases dramatically with invited guests, the amount and frequency of sanitizer required increases dramatically.

PERFORMING SUPER CHLORINATION/ NON-CHLORINE SHOCK TREATMENT

A weekly or monthly super chlorination 1.5 tsp dichlor/950 liters (250 gallons) or shock 4tbs mps/950 liters (250 gallons) may be required of your chosen sanitation program. Increasing chlorine to 5 ppm for 24 - 48 hours removes excess waste and chloramines from the water. Sodium dichlor is 6x stronger than MPS and may be a more appropriate for those users that experience heavy bather load conditions. Operate all jets and leave the cover open for a minimum of 20 minutes to allow the oxidizer gas to vent to prevent damage and discoloration to the cover and pillows after administering a super chlorination or shock to your spa. This type of damage is considered chemical abuse and is not covered under the terms of the limited warranty.

IMPORTANT: Always allow the FAC to fall below 5 ppm before using your spa.

 **DANGER:** Never leave an open spa unattended, especially if there are children present!

FRESHWATER SALT SYSTEM (OPTIONAL)

The Salt System converts water and sodium chloride salt into chlorine sanitizer. This is compatible with chlorine based systems and chemicals. Although the system is reduced maintenance, it is not automatic. It is important that the user regularly tests and balances the water. A calcium hardness between **25 - 75 ppm** is recommended to extend the life of the hardware. Consult the Salt System User Guide for additional instructions.

ADDITIONAL WATER CARE PRODUCTS

- **CLEAN SCREEN** Pre-filter
- **FRESHWATER** Concentrated Chlorinating Granules, Sodium Dichlor
- **FRESHWATER** Chlorine-Free Oxidizer, Monopersulfate (MPS)
- **FRESHWATER** III high output ozone system
- **FRESHWATER**_{Ag+} Silver Ion purifier
- **VANISHING ACT** calcium remover

The Silver Ion purifier introduces silver ions into the spa water via erosion of silver infused beads which inhibits bacteria growth. When combined with MPS, or chlorine, waste is oxidized and removed from the water.

It is important to follow the recommended application and maintenance programs outlined for each product's use. If the spa is being used over an extended period of time, such as a whole afternoon or evening, additional sanitizer will be needed.

Required: Weekly Super Chlorinate/Shock the spa to reactivate the Silver Ion cartridge, allow the release of silver ions, and quickly destroy any remaining contaminants. Without this weekly shock treatment, the Silver Ion cartridge may stop releasing silver ions into the water.

IMPORTANT: Use only Dichlor or liquid chlorine sanitizer. Silver is not compatible with bromine and biguanides. Don't use a water clarifier. Clarifiers will cause the spa water to become cloudy.

MANUAL CHLORINE (SODIUM DICHLOR)

WATKINS WELLNESS recommends the use of **FRESHWATER** Concentrated Chlorinating Granules (sodium dichlor) for sanitizing the water. Sodium dichlor is preferred because it is totally soluble, dissolves quickly, and is nearly pH neutral. The recommended Free Available Chlorine (FAC), the amount of available chlorine to sanitize the spa is 3-5 ppm

If the FAC is too low: Increase the FAC by adding granulated sodium dichlor.

If the FAC is too high: Allow time to pass and the FAC level will naturally drop over time.

If the spa smells of chlorine: super chlorinate or shock the spa FAC chlorine does not have an odor whereas combined spent chlorine (chloramines) has a strong chlorine odor that can be eliminated by shocking the water.

IMPORTANT: There are several forms of stabilized chlorine available for use in spas and swimming pools. It is extremely important to choose one specifically designed for spas. Use of an incorrect product such as tri-chlor which has a very low pH (2.6) and dissolves too quickly in hot water, results in extremely high levels of chlorine that **WILL** cause damage to your spa. Use of a compressed bromine/chlorine or unapproved sanitizer **WILL** damage your spa and is specifically not covered under the terms of the limited warranty.

VANISHING ACT INSTRUCTIONS

(Your spa may look different)



Instructions for Use:

1. After filling your hot tub, use a test strip to measure the hardness level of the water. If hardness is above **100 ppm**, use the **VANISHING ACT** calcium remover to soften the water. **Suggested Hardness Level: between 75 - 150 ppm, (it must be between 25 - 75 ppm when using the FRESHWATER Salt System in order to work).**
2. Rinse the **VANISHING ACT** calcium remover with running water until water runs clear. When placed in the hot tub, slight color transfer to the water may occur and can be easily resolved with chlorine.
3. Locate your heater return in footwell (see illustration above).
 - a. Place the **VANISHING ACT** calcium remover (flat side down) over the heater return.
 - b. After 10-12 hours, flip the calcium remover over and reposition over heater return.
 - c. After a total of 24 hours, take the calcium remover off of the heater return and discard.

Note: DO NOT RUN JETS WHILE CALCIUM REMOVER IS IN PLACE.

IMPORTANT:

- **Always make sure water is balanced and properly sanitized, using the EPA approved sanitizer, before entering your hot tub.**
- **For maximum effectiveness, ensure that the calcium remover remains on the suction fitting while the calcium remover is in use.**
- **Calcium remover may not be necessary if water hardness is already in or below the suggested range.**
- **Multiple calcium removers may be needed if initial water hardness is above 200 ppm.**

OZONE MAINTENANCE (OPTIONAL)

Reduced or no ozone bubbles coming from heater return (clogged ozone injector) or no ozone, clean the injector:

1. Place 0.5 liter (16 ounces) of white vinegar into a cup or bucket.
2. Carefully loosen the long tubing attached to the bottom of the ozonator, located in the equipment compartment.
⚠ DANGER: Place the end of the tubing into the vinegar, making certain that the end of the tubing sits at the bottom of the container.
3. Run the spa until all 0.5 liter (16 ounces) of the vinegar is gone. This should allow an ample flow of vinegar to be run through the injector and clear the blockage.
4. Reinstall the tubing to the bottom of the ozonator.

Water chemistry damage is not covered by the warranty. The chemical levels and water quality in the spa are under your direct control. With proper basic care, the spa will provide many years of hot water relaxation. If you are unsure about any chemical or its usage in the spa, contact your Authorized Dealer, or **WATKINS WELLNESS**.

DO:

- Add all chemicals slowly into the filter compartment with the jet pump operating for ten minutes.
- Use granular (dichlor) or liquid (sodium hypochlorite) chlorine.
- Use special care if using baking soda to clean either the interior or exterior plastic surfaces.

IMPORTANT: WATKINS WELLNESS DOES NOT recommend the use of any floating chemical dispenser. Damage to the spa shell or components caused by a floating chemical dispenser is specifically not covered under the terms of the limited warranty. Floating dispensers can become trapped in one area and cause an over-sanitization or release large chunks of sanitizer that very quickly chemically burns the shell and cover.

DON'T:

- Use compressed sanitizers.
- Use a floater type sanitization system as a low or no maintenance solution to your spa maintenance program.
- Use a sanitizer which is not designed for spas.
- Use swimming pool (muriatic) acid to lower pH.
- Broadcast or sprinkle the chemicals onto the water surface. This method may cause chemically-induced spa surface blistering (chemical abuse).

VACATION WATER CARE INSTRUCTIONS

If you plan to be away from home, follow these instructions to ensure that the water quality of your spa is maintained:

SHORT TIME PERIODS (3-5 DAYS)

1. Adjust the pH by following the instructions outlined in the Water Quality and Maintenance section.
2. Sanitize the water by following the shock procedures also listed in the Water Quality and Maintenance section.
3. Lock your cover in place using the coverlocks.
4. Upon your return, sanitize the water by following the shock procedures, and balance the pH.
5. If Salt System is installed, please refer to Tips section, vacation or limited use in the Salt System Owner's Manual.

LONG TIME PERIODS (5-14 DAYS)

Prior to leaving:

1. At least one day before you leave, set the temperature to its lowest level. This setting should represent an approximate water temperature of 26°C (80°F).

IMPORTANT: Spa water oxidizers such as sodium dichlor (chlorine) maintain their level of effectiveness substantially longer in warm water 26°C (80°F) than in hot water 38°C - 40°C (101°F to 104°F).

2. Adjust the pH as required. Sanitize the water by following the shock procedures.

Upon your return:

3. Sanitize the water by following the shock procedures. Return the set temperature to its original setting. The spa water will be safe for you to use once the Free Available Chlorine residual level has dropped below 5.0 ppm.

IMPORTANT: If you will not be using your spa for an extended period of time (in excess of 14 days) and an outside maintenance service (or neighbor) is not available to assist with the water maintenance, draining or winterizing of the spa is recommended. Spas equipped with our **FRESHWATER** III ozone system can extend this to 4 weeks. The **FRESHWATER** III ozone system does not guard against possible freezing damage, however.

SUPPLEMENTAL WATER MAINTENANCE

Proper water sanitation and mineral balance (pH control) are absolutely essential for a complete spa water maintenance program. Here are two other popular water additives that are optional:

Mineral Deposit Inhibitors

As water evaporates from your spa and new water is added, the amount of dissolved minerals will increase. Minimize evaporation by keeping the cover on the spa whenever possible. The spa water may eventually become "hard" (calcium hardness too high) enough to damage the heater by calcifying its surface. Proper pH control can minimize this.

Normal soap build-up will require water replacement regularly enough that mineral deposits normally are not a problem.

Occasionally, high iron or copper content in the water may produce green or brown stains on the spa. A stain and scale inhibitor may help to reduce these metals.

IMPORTANT: Well water may contain high concentrations of minerals. The use of a low water volume, extra-fine pore water filter (in-line pre-filter such as the **CLEAN SCREEN** pre-filter) will help to remove many of the larger particles during the filling of the spa. In-line pre-filters can be purchased at your local **HOT SPRING** dealer.

Foam Inhibitors

Spa water requires changing due to the buildup of soap in the water. Typically, soap will cause the spa water to foam when the jets are used. Soap is introduced into the spa water from two sources: users' bodies, which retain a soap residual after showering, and swimming apparel, which retains soap after washing.

Foam inhibitors can suppress foam, but cannot remove soap from the water. Soap is very difficult to remove from the water because soap is not oxidized by any chemical added to the spa. Only ozone can oxidize soap.

Eventually the soap build-up in the water will be concentrated, resulting in an unclear feeling on the bather's skin, which is impossible to remedy. When this occurs, it's time to drain and refill the spa. Depending on the soap input, the water should last about four months before needing to be drained.

WATER TERMINOLOGY

The following chemical terms are used in this Water Quality and Maintenance section. Understanding their meaning will help you to better understand the water maintenance process.

Bromamines: Compounds formed when bromine combines with nitrogen from body oils, urine, perspiration, etc. Unlike chloramines, bromamines have no pungent odor, and are effective sanitizers.

Bromine: A halogen sanitizer (in the same chemical family as chlorine). Bromine is commonly used in stick, tablet, or granular form.

Calcium Hardness: The amount of dissolved calcium in the spa water. This should be approximately 75 - 150 ppm (Salt System: 25 - 75 ppm). High levels of calcium can cause cloudy water and scaling. Low levels can cause harm to the spa equipment.

Chloramines: Compounds formed when chlorine combines with nitrogen from body oils, urine, perspiration, etc. Chloramines can cause eye irritation as well as having a strong odor. Unlike bromamines, chloramines are weaker, slower sanitizers.

Chlorine: An efficient sanitizing chemical for spas. **WATKINS WELLNESS** recommends the use of sodium dichlor-type granulated chlorine. This type is preferred because it is totally soluble and nearly pH neutral.

Chlorine (or Bromine) Residual: The amount of chlorine or bromine remaining after chlorine or bromine demand has been satisfied. The residual is, therefore, the amount of sanitizer which is chemically available to kill bacteria, viruses and algae.

Corrosion: The gradual wearing away of metal and plastic spa parts, usually caused by chemical action. Generally, corrosion is caused by low pH or by water with levels of TA, CH, pH or sanitizer which are outside the recommended ranges.

Halogen: Any one of these five elements: fluorine, chlorine, bromine, iodine, and astatine.

MPS: Monopersulfate is the non-chlorine oxidizer used with the **FRESHWATER_{Ag+}** silver ion purification system. Not a sanitizer.

Nitric Acid: The formulation of nitric acid, a highly corrosive chemical, is a byproduct of the ozone generating process. Nitric acid is produced in very small quantities and is readily dissolved in the water stream with ozone.

Oxidizer: The use of an oxidizing chemical is to prevent the buildup of contaminants, maximize sanitizer efficiency, minimize combined chlorine and improve water clarity. See MPS and Ozone.

Ozone: Ozone is a powerful oxidizing agent which is produced in nature and artificially by man. Ozone forms no byproducts, oxidizes chloramines, and will not alter the water's pH.

pH: The measure of the spa water's acidity and alkalinity. The recommended pH for the spa water is 7.2 to 7.8. Below 7.0 (considered neutral), the spa water is too acidic and can damage the heating system. Above 7.8, the water is too alkaline and can result in cloudy water, and scale formation on the shell and heater.

ppm: The abbreviation of "parts per million", the standard measurement of chemical concentration in water. Identical to mg/l (milligrams per liter).

Reagent: A chemical material in liquid, powder, or tablet form for use in chemical testing.

Sanitizer: Sanitizers are added and maintained at recommended residuals to protect bathers against pathogenic organisms which can cause disease and infection in spa water.

Scale: Rough calcium-bearing deposits that can coat spa surfaces, heaters, plumbing lines, and clog filters. Generally, scaling is caused by mineral content combined with high pH. Additionally, scale forms more readily at higher water temperatures.

Super-Chlorination: Also known as "shock treatment." Super-Chlorination is a process of adding significant doses of a quick dissolving sanitizer ("dichlor" is recommended) to oxidize non-filterable organic waste and to remove chloramines and bromamines.

Total Alkalinity (TA): The amount of bicarbonates, carbonates, and hydroxides present in spa water. Proper total alkalinity is important for pH control. If the TA is too high, the pH is difficult to adjust. If the TA is too low, the pH will be difficult to hold at the proper level. The desired range of TA in spa water is 40 to 120 ppm.

OPERATING INSTRUCTIONS

WIRELESS REMOTE CONTROL

OPERATING YOUR REMOTE



The **HOT SPRING** Wireless Control Panel features a full color LCD touchscreen to operate all spa functions and features, wireless communication to the control system, and wireless charging via the bartop docking tray.

When activating a function or feature, press with a light but distinctive touch, the function or feature will activate as your finger is removed from the touchscreen.



IMPORTANT: Never sit, stand or lean on the LCD touchscreen when entering or exiting the spa because it may damage the screen.

- The wireless remote control panel should be placed in the docking tray when not in use.
- Remote control can be placed into docking tray facing either direction.
- Maximum recommended operable distance between remote and dock is 9 m (30'). Any obstructions between remote and dock may prevent the remote from communicating, including through the spa water.
- A convenience tray on the bartop is available as a secondary placement location while spa is in use. The remote should always be returned to the docking tray before placing cover over your spa.

VERY IMPORTANT: Your wireless remote is a high tech device designed for use in your spa, handle accordingly!

- The wireless remote control (IP67 rated) is immersible and floatable if it is inadvertently dropped into the spa water.
- Never immerse or float remote in the spa for any extended period of time.
- Do not allow remote to float inside filter area. Extreme turbulence and impact can render the remote permanently inoperable.
- Dropping the remote on any hard surface may break the screen rendering the remote permanently inoperable. Physical abuse is not covered under warranty.
- Remote control will NOT communicate to spa dock if underwater.
- Remote should NOT be docked or stored in ambient temperature ranges outside of -30° C to +50° C (-20° F to +122° F).
- Radio environments will vary and may occasionally lose connection between remote and spa or possibly return you back to the home screen on the remote. This is normal and regular operation should resume within a few seconds. If loss of communication persists, consult Troubleshooting section.
- Do not leave remote exposed to direct sunlight for long periods of time, as solar heat could cause issues with the touch screen.

BATTERY

For best battery performance, place the wireless remote back in the charging dock when not in use. When not in dock, even in sleep mode, the battery will consume power. If battery is depleted, return remote control to the dock for immediate recharging. When returned to the dock, all spa functions will be operable but the

remote should remain in the dock until fully charged. Under normal conditions a fully drained battery will take 6-8 hours to recharge. Contact your authorized **HOT SPRING** Dealer for replacement of your Lithium Ion battery.

CARE OF YOUR REMOTE:

Use only a clean microfiber cloth and water to clean your LCD screen. Abrasive cloths, towels, paper towels, and similar items may cause damage to the remote screen. Don't use around aerosol sprays, solvents, or abrasives.

WIRELESS REMOTE DISPLAY TIME OUTS:

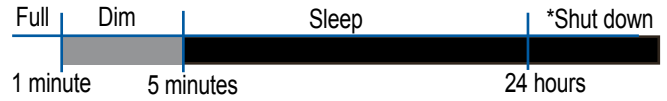





The remote screen will dim after 1 minute and sleep after 5 minutes. * Remote will only shut down if it is NOT in the docking station for 24 hours. To restart, press the touchscreen and wait for 40 seconds as remote re-boots and loads screens.



HOME SCREEN



The Home screen is the default screen. The temperature displayed inside the Home screen is the actual temperature of the spa water.











NOTE: The wireless remote will revert back to the Home screen after 45 seconds of non use in any other screen.

Home Screen Functions:		
	Power Button	Press this icon to turn jets on high and all lights on blue if both are currently off, or will turn all jets, lights, and music off if those features are currently on.
	Memory Screen	Press this icon to access the Memory screen.
	Clean Cycle	Press this icon to access the Clean Cycle screen. Icon will flash when Clean Cycle is on.
	Settings Screen	Press this icon to access the first Settings screen.

Home Screen Features		
	Jets	Press this icon to access the Jets Control screen.
	FRESHWATER Salt System	<i>If installed</i> , press this icon to access the FRESHWATER Salt System screen.

Home Screen Features - Continued		
	Music	If installed, press this icon to access the first music screen.
	Lights	Press this icon to access the first Lights screens.

Status Indicators		
	Summer Timer or Auto Clean	This indicator is on whenever the Summer Timer is ON or Auto Clean is activated.
	Spa/Temp Lock	This indicator is on whenever the Spa Lock or Temperature Lock is ON.
	Battery Life	This indicator tells you how much battery life is still available to the wireless remote control.
	Battery Charging	A flashing indicator tells you when the battery is charging in the dock. When indicator is solid, battery is charged.
	FRESHWATER Salt System	This indicator appears when the FRESHWATER cartridge is over 4 months old and should be changed soon.

Working Screen Icons		
	Home Icon	Press to return to the Home screen.
	Return Icon	Press to return to the previous screen.
	Advance Icon	Press to advance to the next screen.

TEMPERATURE CONTROL

38.5°C



Press the actual temperature on Home screen to display Set Temperature screen.



The set temperature range is from 26°C to 40°C (80°F to 104°F).
NOTE: The water temperature may vary depending on the current use and condition of your spa and outside temperatures.

The factory set temperature of the spa water is 38°C (100°F).

After the spa has been used, the last temperature value set by the user will be stored in memory. If power is disconnected from the spa, it will automatically revert to the last set temperature when power is reapplied.

-  Press to raise set temperature of spa. Press and hold to raise the temperature continuously.
-  Press to lower set temperature of spa. Press and hold to lower the temperature continuously.

MEMORY SCREEN

Press  on Home screen to display Memory screen.

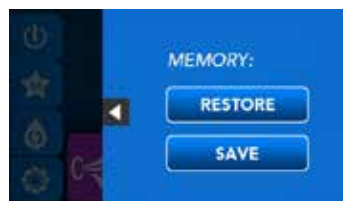

Press to activate the last saved set of operating functions.



Press to save the current set of operating functions (jets and lights only).



Press to return to home screen if neither of the above buttons are used. Screen will automatically revert back after 10 seconds of non activity.

CLEAN CYCLE SCREEN

Press  on Home screen to display Clean Cycle screen.

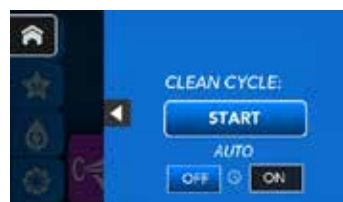

Press to start the manual Clean Cycle. The screen will briefly display CLEAN CYCLE: ACTIVE. Activates jet pump 1 on high speed for a ten minute period.



Press & hold to activate and deactivate the Auto Clean Cycle. If activated, a clean cycle will run every 24 hours starting at the time ON was first pressed (runs Jet 2 for 1 minute and Jet 1 for 9 minutes, 10 minutes for spas that only have Jet 1).



Press to return to Home screen. Screen will automatically revert back after 10 seconds of non activity.

SETTINGS SCREENS

Press  on Home screen to display first Settings Screen.



The first Settings screen allows you to turn Temperature Lock, Spa Lock, Lights Timer and Summer Timer On or Off.

TEMPERATURE LOCK

Press  on Home screen to display Temperature Lock.



The Temperature Lock feature prevents changing the desired water temperature setting. All other control panel functions will operate normally while the Temperature Lock is "ON".



Press and hold ON or OFF for **approximately 4 seconds** to activate or deactivate.

SPA LOCK

Press  on Home screen to display Spa Lock.



When activated, the Spa Lock feature disables all functions on the control panel.

The control panel will not respond to anything except  on the Home screen.



Press and hold ON or OFF for **approximately 4 seconds** to activate or deactivate.

LIGHTS TIMER

Press  on Home screen to display Lights Timer.



When activated, the exterior lights of the spa will come on 5 seconds later and will remain lit for 6 hours and repeat the cycle every 24 hours from activation time.



Press ON or OFF to activate or deactivate.

SUMMER TIMER

Press  on Home screen to display Summer Timer.



- The Summer Timer can be activated during extremely hot summer months to help maintain set water temperatures.

- Activating the Summer Timer causes the heater to immediately shut down. The



circulation pump will remain on for approximately 5 minutes pushing water through the heater to cool it down.

- Both heater and circulation pump will remain off for eight hours. The circulation pump and heater will automatically shut down for the same eight hours every day until the Summer Timer is deactivated.
- It is recommended to activate the Summer Timer in the morning so that the spa is off during the hottest part of the day and so that the circulation pump will start up again in the evening when you are ready to enjoy the spa.



Press ON or OFF to activate or deactivate.

TEMPERATURE °F/°C SETTING



Press  on Home screen to display first Settings screen, then press  to display Temperature in second Settings screen .



Press °F or °C to activate either Fahrenheit or Celsius temperature.



SCREEN BRIGHTNESS

Press  on Home screen to display first Settings screen, then press  to display Brightness in second Settings screen.

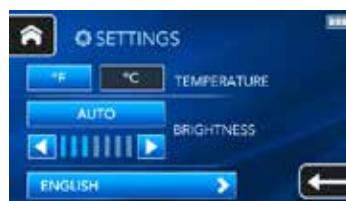



Auto Brightness Sensor





Press if the box is dark to activate the auto brightness feature, a sensor (located to the left of LCD screen) will automatically adjust the LCD to the ambient lighting conditions.



Press  or  to turn AUTO brightness off and manually increase or decrease the brightness of the remote's screen. Press and hold either arrow to continuously change the brightness setting.

LANGUAGE

Press  on Home screen to display first Settings screen, then press  to display the current language in second Settings screen.



The control panel screens can be viewed in different languages (ENGLISH illustrated).



Press to display Select Language screen.



NOTE: Press  to see more languages.

Press on the new desired language.



Press to start the conversion process. A black reset screen will appear and begin the converting process. The conversion is finished once the Home screen reappears.



Press to return to second Settings screen if check mark icon is not pressed. Screen will automatically revert back after 10 seconds of non activity.





JETS CONTROL SCREEN

Press  on the Home screen to display the Jets screen.



NOTE: If jets are off when  is pressed on the Home screen, low speed jet pump will turn on for **GRANDEE, ENVOY, ARIA, VANGUARD & SOVEREIGN.**

TRIUMPH, PRODIGY, JETSETTER LX & JETSETTER screen will only display OFF and high speed.

-  Press to turn Jet pump Off.
-  Press to turn Jet pump on low speed.
-  Press to turn Jet pump on high speed.
-  Press to turn ALL jet pumps off (if on) or all to High speed (if off).

SALT SYSTEM SCREEN (OPTIONAL)

Press  on the Home Screen to display salt system screen.

The icon will only display on the Home screen if the spa has the **FRESHWATER** Salt System installed.



See the **FRESHWATER** Salt System Owner's Manual for more information.

MUSIC SYSTEM SCREEN (OPTIONAL)

Press  on the Home screen to access the Music System screen.

The Music icon will only display on the Home screen if your spa has the Music System installed.



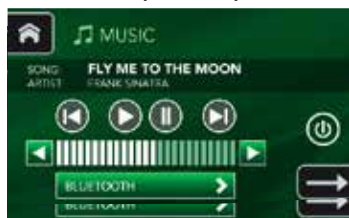

-  Press to turn the Music system On.

NOTE: When the Music system is turned Off there is an 8 second delay before Music system may be turned back ON.



The primary Music screen will display a music player with volume control and a Music Source selection box.

-  Press to turn the Music system Off.

 The player functions consist of Track Down, Play, Pause and Track Up

 Press  or  to decrease or increase the volume.

 Press to display the Select Music Source screen.



Press on the new desired Music source.

- TV** This source requires a spa TV only available from your **HOT SPRING** dealer.
- AUX** Source from a line level audio input
- BLUETOOTH** This source will work with any Bluetooth device. Find **My Spa BTXR** on your Bluetooth device when pairing to spa (see pairing information below).



 Press to return to Primary Music screen. Screen will automatically revert back after 10 seconds of non activity.



IMPORTANT: When using the Bluetooth source, the player functions may or may not work depending on your Bluetooth device. Not all Bluetooth devices will respond to player functions. Volume control will work on all audio sources.



 Press to advance to Secondary Music screen.



Press  or  to decrease or increase the value for each music feature.

Bass, Treble and Balance range is from -5 to +5.

Subwoofer range is from 0 to 11.

Press  in Tools to scroll between PAIR, SIGNAL and RESET, press  in Tools to activate the current function.

To PAIR your device:

- On your device, find **My Spa BTXR**. If you do not see this, another device may already be connected (see RESET below To Disconnect another Bluetooth device).
- Press  with PAIR illustrated inside TOOLS box followed by pressing "connect" next to **My Spa BTXR** on your device to pair.

After pairing, you will be ready to use your Bluetooth device. Only one paired Bluetooth device will work at a time.

Use RESET to disconnect any device using the spa music system so that another paired device may be used. This is also necessary when trying to pair multiple devices because pairing is NOT possible when another device is connected to the music system.



- Press  with RESET illustrated inside TOOLS box to remove any device connected to the music system.

To view the signal strength between your Bluetooth device and the music system Press  with SIGNAL illustrated inside TOOLS box.



LIGHTS CONTROL SCREEN



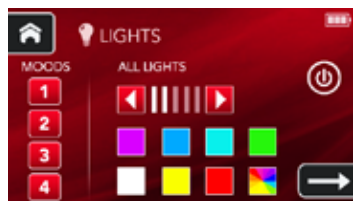

Press  on the Home screen to access the primary Lights screen.









NOTE: If lights are off when  is pressed on the Home screen, all light zones will turn on to blue.

The primary Lights screen is divided into two sections, the MOODS section and the ALL LIGHTS section.

MOODS (Preset colors and brightness):

-  Press to turn On Underwater lights (blue color).
-  Press to turn On Underwater (magenta), Bartop and Pillow (aqua) and Exterior lights (white).
-  Press to turn On Underwater & Pillow lights (aqua).
-  Press to turn On Pillow lights (white).







ALL LIGHTS:

-  Press to turn all lights On or Off. When all lights are turned On they will all be blue.
-  Press  or  to decrease or increase the brightness setting for all lights that are currently on.
-  Press any of the color boxes to turn that color on in all light zones.
-  Press the multicolored box to turn color wheel on for all light zones. Press the color wheel a second time to stop the color wheel at a desired color.
-  Press to advance to the secondary Lights screen.



Select the color and brightness for each desired light zone.

NOTE: Different colors and brightness settings can be selected for each individual zone.

-  Press the button next to the zone description to select the desired lighting zone (only one light zone can be selected at a time).
-  Press  or  to decrease or increase the brightness setting for selected light zone.
-  Press any of the color boxes to turn that color on in the selected light zone.
-  Press the multicolored box to turn color wheel on for selected light zone. If more than one zone uses the color wheel, the colors will automatically synchronize. Press the color wheel a second time to stop the color wheel at a desired color.

DOCKING TRAY FUNCTION BUTTONS



In the event the remote is not nearby, you can still operate the Jets and Lights by pressing the buttons located in the docking tray.

LIGHTS Button:

Press the Lights button once to turn on all light zones in blue. Continue pressing the Lights button to dim all lights until the 5th press turns them off.

JETS Button:

Press the Jets button several times to turn each sequence of jet combinations On followed by turning all jets Off

GRANDEE, ENVOY, ARIA, & VANGUARD

- 1st Press Jet 2 on low speed
- 2nd Press Jet 2 on high speed
- 3rd Press Jet 1 and 2 on high speed
- 4th Press Jet 1 on high speed, Jet 2 on low speed
- 5th Press Jet 1 on High
- 6th Press Jet 1 and Jet 2 Off

SOVEREIGN

- 1st Press Jet on low speed
- 2nd Press Jet on high speed
- 3rd Press Jet Off

TRIUMPH, PRODIGY, JETSETTER LX & JETSETTER

- 1st Press Jet on high speed
- 2nd Press Jet Off

Pairing Dock with Remote:

Pairing is only required if the remote is within range of the dock and the screen on the remote continues to read "Searching for Spa".

- Press and hold the JETS button on the dock until JETS and LIGHTS buttons flash.
- Press and hold remote screen until Pairing Menu is displayed.
- Press Yes to begin the Pairing.

Changing Frequency Channel between Dock with Remote:

Change the channel if remote continues having intermittent response when inside the 9 m (30') usable range.

- Press and hold the LIGHTS button on the dock until JETS and LIGHTS buttons flash.
- Press UP or DOWN on remote to change the channel number.
- Press OK to set the new frequency.

JET MENU

GRANDEE (MODEL GGNE)

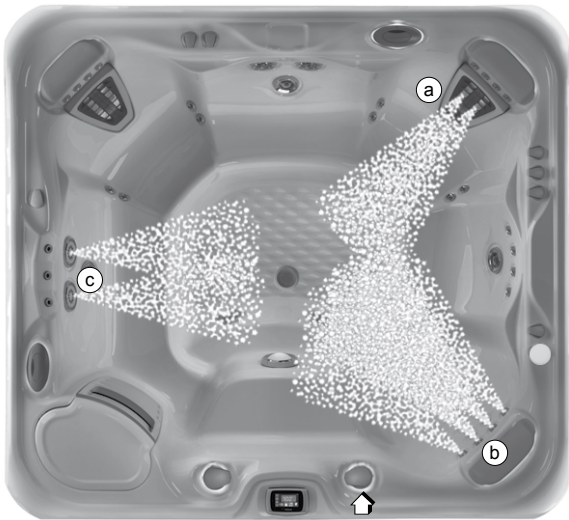

JET PUMP 1-JET SYSTEM 1

Right SMARTJET lever in  position

- a. 1 **MOTO-MASSAGE DX** jet
- b. 10 directional **PRECISION** jets
- c. 2 **SOOTHINGSTREAM** jets



JET PUMP 2-JET SYSTEM 1

Left SMARTJET lever in  position

- a. 1 **MOTO-MASSAGE DX** jet
- b. 8 directional **PRECISION** jets
- c. 1 directional hydromassage jet
- d. 1 Water Feature
- e. 1 **FOOTSTREAM** jets

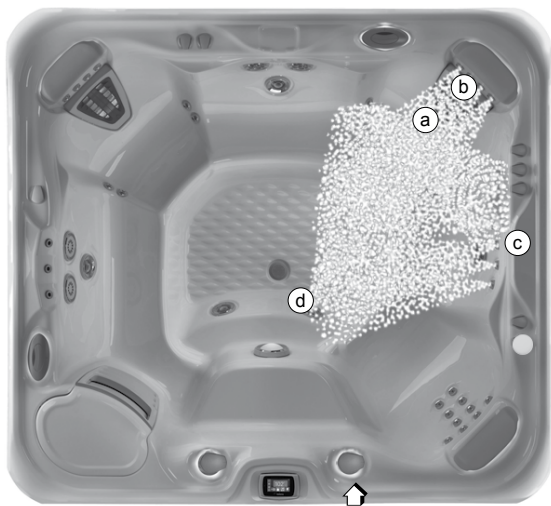

JET PUMP 1-JET SYSTEM 2

Right SMARTJET lever in  position

- a. 1 **MOTO-MASSAGE DX** jet
- b. 8 directional **PRECISION** jets
- c. 4 directional **PRECISION** jets
- d. 1 **FOOTSTREAM** jets



JET PUMP 2-JET SYSTEM 2

Left SMARTJET lever in  position

- a. 1 **MOTO-MASSAGE DX** jet
- b. 3 Jet-Cluster (2-dual port rotary jets, 1 directional hydromassage jet)
- c. 1 **FOOTSTREAM** jet
- d. 1 directional hydromassage jet
- e. 1 Water Feature

ENVOY (MODEL KKNE)



JET PUMP 1-JET SYSTEM 1

Left SMARTJET lever in  position

- a) 2 rotary **PRECISION** jets
- b) 7 directional **PRECISION** jets
- c) 1 **MOTO-MASSAGE DX** jet
- d) 4 directional **PRECISION** jets
- e) 4 directional **PRECISION** (calf) jets
- f) 2 **HYDROSTREAM** jets



JET PUMP 2-JET SYSTEM 1

Right SMARTJET lever in  position

- a) 4 **HYDROSTREAM** jets
- b) 2 **SOOTHINGSTREAM** jets
- c) 1 **FOOTSTREAM** jets
- d) 1 Water Feature

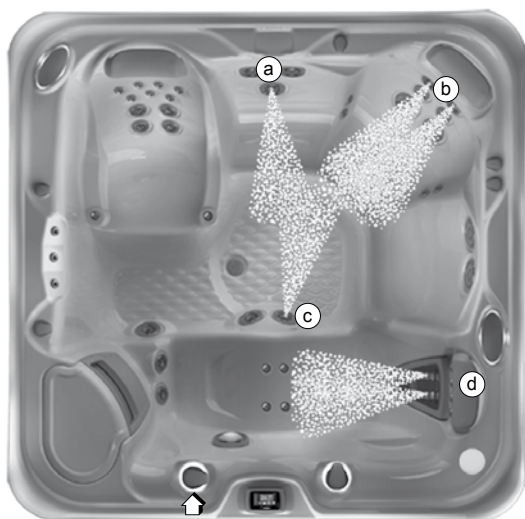

JET PUMP 1-JET SYSTEM 2

Left SMARTJET lever in  position

- a) 1 directional hydromassage jet
- b) 4 **HYDROSTREAM** jets
- c) 1 **FOOTSTREAM** jets
- d) 1 **MOTO-MASSAGE DX** jet

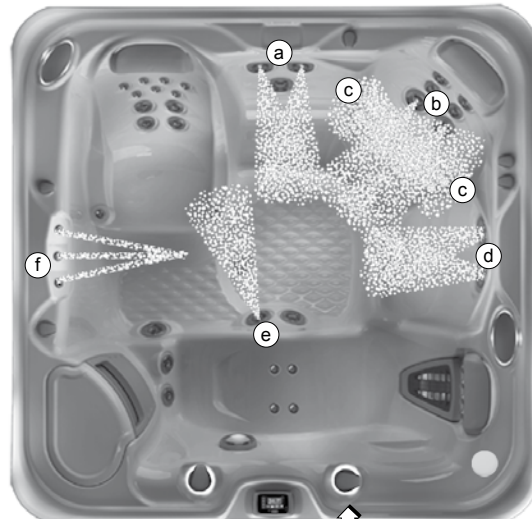

JET PUMP 2-JET SYSTEM 2

Right SMARTJET lever in  position

- a) 2 dual port rotary jets
- b) 2 directional hydromassage jets
- c) 4 directional **PRECISION** jets
- d) 2 **SOOTHINGSTREAM** jets
- e) 1 **FOOTSTREAM** jets
- f) 1 Water Feature

VANGUARD (MODEL VVNE)

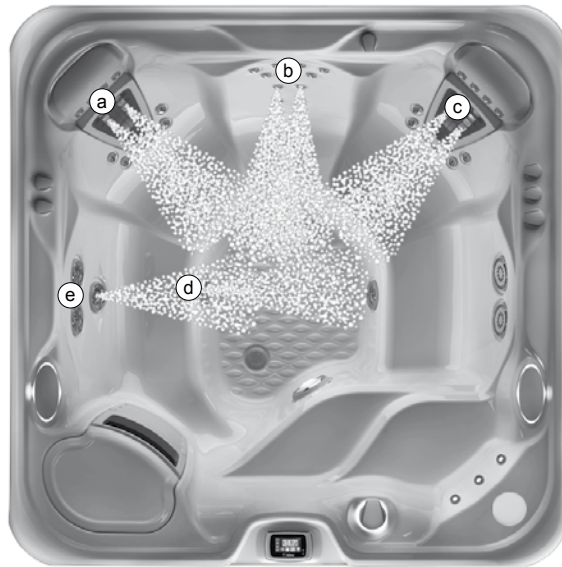

JET PUMP 1-JET SYSTEM 1

- a. 1 **MOTO-MASSAGE** DX jet
- b. 4 directional **PRECISION** jets
- c. 1 **MOTO-MASSAGE** DX jet
- d. 1 **FOOTSTREAM** jet
- e. 1 directional hydromassage jet

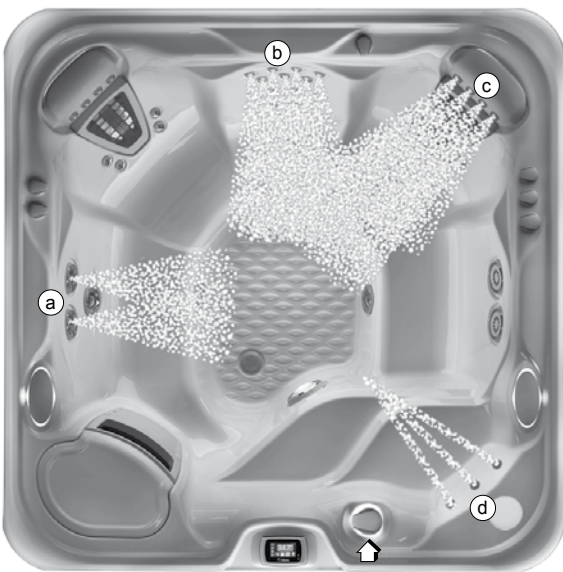

JET PUMP 2-JET SYSTEM 1

SMARTJET lever in  position

- a. 2 dual port rotary jets
- b. 7 directional **PRECISION** jets
- c. 8 directional **PRECISION** jets
- d. 1 water feature



JET PUMP 2-JET SYSTEM 2

SMARTJET lever in  position

- a. 8 directional **PRECISION** jets
- b. 2 **SOOTHINGSTREAM** jets
- c. 1 **FOOTSTREAM** jet
- d. 1 water feature

ARIA (MODEL ARNE)



JET PUMP 1

- a. 4 **PRECISION** jets
- b. 4 **HYDROSTREAM** jets
- c. 1 directional hydromassage
- d. 1 **MOTO-MASSAGE DX** jet
- e. 1 **FOOTSTREAM** jet

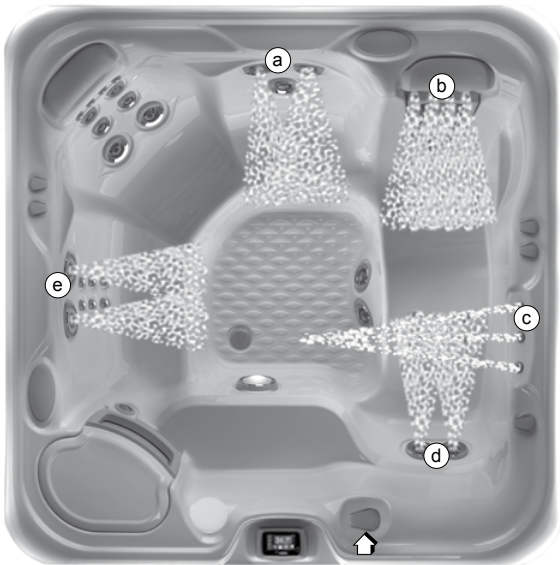

JET PUMP 2-JET SYSTEM 1

SMARTJET lever in  position

- a. 2-dual port rotary jets
- b. 4 **PRECISION** jets above **MOTO-MASSAGE DX**
- c. 1 water feature
- d. 2 directional hydromassage
- e. 2 **SOOTHING SEVEN** jets



JET PUMP 2-JET SYSTEM 2

SMARTJET lever in  position

- a. 2 directional hydromassage
- b. 1 water feature
- c. 4 **PRECISION** jets
- d. 1 **FOOTSTREAM** jet
- e. 6 **PRECISION** jets

SOVEREIGN (MODEL IINE)

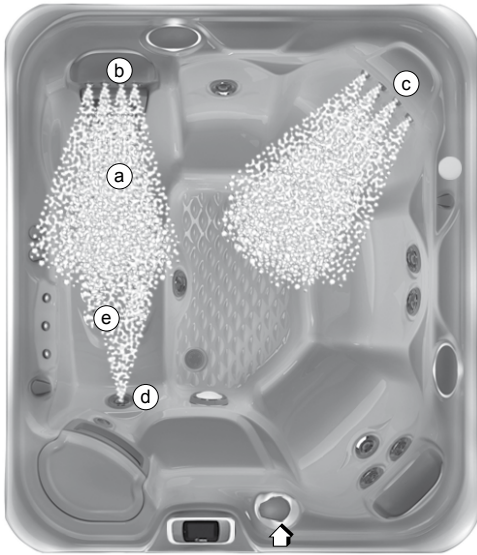

JET SYSTEM 1

SMARTJET lever in  position

- a) 1 **MOTO-MASSAGE DX** jet
- b) 4 directional **PRECISION** jets
- c) 10 directional **PRECISION** jets
- d) 1 directional hydromassage jets
- e) 4 directional **PRECISION** (calf) jets

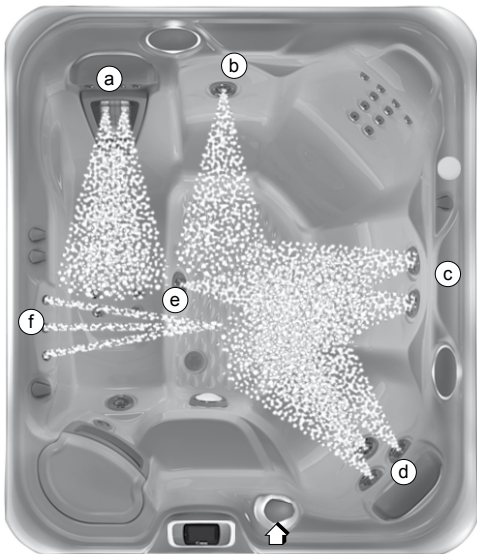

JET SYSTEM 2

SMARTJET lever in  position

- a) 1 **MOTO-MASSAGE DX** jet
- b) 1 directional hydromassage jet
- c) 2 **SOOTHINGSTREAM** jets
- d) 3 Jet-Cluster system (2-dual port rotary, 1-directional hydromassage)
- e) 1 **FOOTSTREAM** jets
- f) 1 Water Feature

TRIUMPH (MODEL TRHNE)

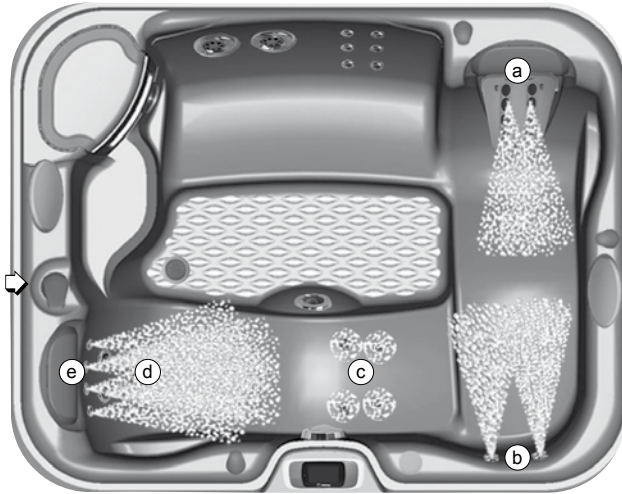

JET SYSTEM 1

SMARTJET lever in  position

- a) 1 **MOTO-MASSAGE DX** jet
- b) 4 Directional **PRECISION** jets in Lounge (feet)
- c) 4 Directional **PRECISION** jets (calf jets)
- d) 4 Directional **HYDROSTREAM** jets
- e) 4 Directional **PRECISION** jets

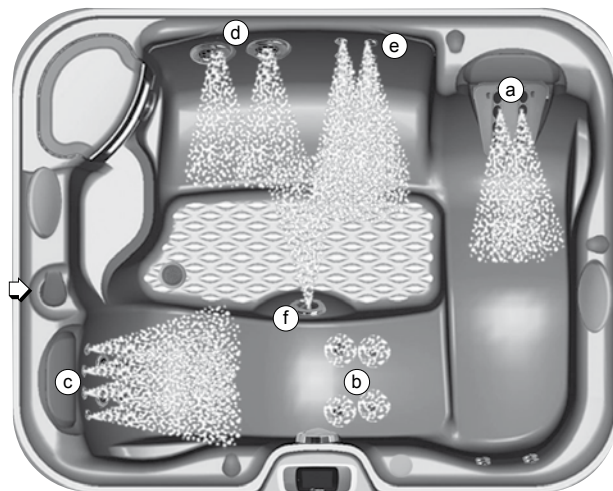

JET SYSTEM 2

SMARTJET lever in  position

- a) 1 **MOTO-MASSAGE DX** jet
- b) 4 Directional **PRECISION** jets (calf jets)
- c) 4 Directional **PRECISION** jets
- d) 2 **SOOTHINGSTREAM** jets
- e) 6 Directional **PRECISION** jets
- f) 1 **FOOTSTREAM** jets

PRODIGY (MODEL HNE)



JET SYSTEM 1

SmartJet lever in  position

- a) 1 **MOTO-MASSAGE DX** jet
- b) 4 directional **PRECISION** jets
- c) 1 **FOOTSTREAM** jet
- d) 2 dual port rotary jets
- e) 2 **SOOTHINGSTREAM** jets



JET SYSTEM 2

SmartJet lever in  position

- a) 1 **MOTO-MASSAGE DX** jet
- b) 10 directional **PRECISION** jets
- c) 3 Jet-Cluster system (2-dual port rotary, 1-directional hydromassage)

JETSETTER LX (MODEL JTNE)



JET SYSTEM 1

SMARTJET lever in  position

- a) 1 **FOOTSTREAM** jet
- b) 4 **HYDROSTREAM** jets
- c) 4 directional **PRECISION** jets
- d) 1 **MOTO-MASSAGE DX** jet
- e) 4 directional **PRECISION** (calf) jets

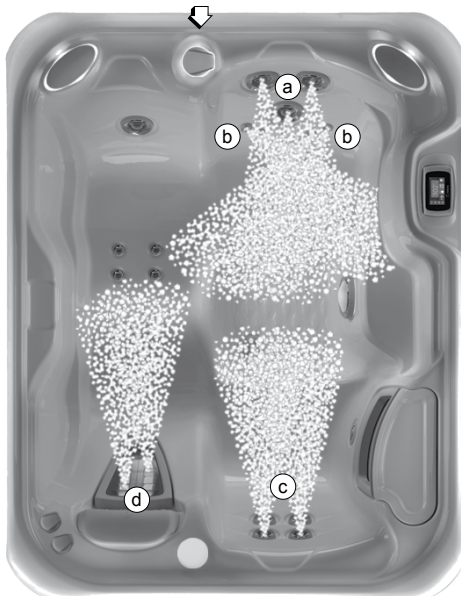

JET SYSTEM 2

SMARTJET lever in  position

- a) 3 Jet-Cluster system on front right (2-dual port rotary jets, 1 directional hydromassage jet)
- b) 4 directional **PRECISION** jets
- c) 4 **HYDROSTREAM** jets
- d) 1 **MOTO-MASSAGE DX** jet

JETSETTER (MODEL JJNE)



JET SYSTEM 1

SMARTJET lever in  position

- a) 1 FOOTSTREAM jet
- b) 4 HYDROSTREAM jets
- c) 4 directional PRECISION jets
- d) 1 MOTO-MASSAGE DX jet



JET SYSTEM 2

SMARTJET lever in  position

- a) 3 Jet-Cluster system on front right (2-dual port rotary jets, 1 directional hydromassage jet)
- b) 4 HYDROSTREAM jets
- c) 1 MOTO-MASSAGE DX jet

SPA CARE AND MAINTENANCE

Your **HOT SPRING** spa is manufactured from the highest quality, most durable materials available. Even so, the spa care and maintenance program you develop will ultimately determine how long your spa, and its individual components, will last. Regular maintenance and following the advice in this section will help you to protect your investment.

DRAIN & REFILL INSTRUCTIONS

IMPORTANT: It is NOT recommended to refill your spa when the ambient temperature goes below 10° C (50° F).

1. Disconnect the spa from the power supply by tripping both of the GFCI breakers located in the subpanel.
2. Locate the main drain valve for the spa and remove the drain cap. Attach the inlet of a garden hose to the drain valve (to avoid flooding of the foundation surrounding the spa) and route the outlet of the hose to an appropriate draining area. Spa water with a high sanitizer level may harm plants and grass.
3. Open the valve by turning the knob. The spa will drain by gravitational flow.
IMPORTANT: All **HOT SPRING** spa models will drain almost completely through the main drain valve and the secondary drain. Equipment such as the jet pump and heating system will drain. Any water remaining within the plumbing or equipment after draining will only need to be removed if the spa is being winterized.
4. Allow most of the water to drain through the main drain.
5. Remove threaded cap from secondary drain. This will drain the remaining water (about 4 liters (1 gallon)) from the bleedline system.
6. When empty, inspect the spa shell and clean as required. (Follow the Care of the Exterior instructions.)
7. Close the drain valve and reinstall the drain cap.
8. Reinstall threaded cap onto secondary drain.
9. Install new filters or clean existing with **FRESHWATER** Filter Cleaner.
IMPORTANT: Always clean and rotate the filter cartridges each time the spa is drained for cleaning.
10. Refill the spa through the filter compartment using the **CLEAN SCREEN** pre-filter.
IMPORTANT: Refill water temperature must be between 10° - 21°C (50° - 70°F) to avoid high-limit tripping.
11. Follow the Quick Start-Up instructions in the Getting Started section.

COLD WATER REFILL

- When refilling your spa if the tap water is below 10° C (50° F) the spa may go into a High Limit Protection mode (causing your spa to stop functioning). If high limit tripping does occur, the fastest way to reactivate the spa control system is to first disconnect power to the spa completely, then warm the two sensors on top of the heater and the vinyl tubing (located in the equipment compartment) with a hair dryer for approximately 10 minutes. Once you believe the sensors and heater tubing have been warmed sufficiently, reconnect power to the spa.

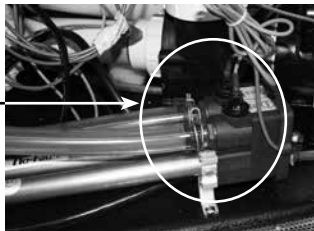

- Blending warm water with the cold tap water so it exceeds 10° C (50° F) during the refilling process will also achieve the same results if that is an option for you.

PREVENTION OF FREEZING

Your spa has been designed and engineered for year-round use in any climate. In some areas, extremely cold temperatures below -12°C (10°F) combined with strong wind, may cause partial freezing of the jet pump, even though the water inside the spa remains at the selected temperature. The energy efficiency of the spa may also decrease during these cold periods, as the heater will cycle more frequently. As an additional precaution against partial freezing of some of the components, the equipment compartment can be insulated with an insulating kit (available from your local dealer part # 31399). This insulating kit will also help to maximize the spa's energy efficiency.

IMPORTANT: When warmer weather returns approx. 15° - 21°C (60°-70°F), the insulating kit must be removed to prevent overheating of the jet pump.

WINTERIZING YOUR SPA

If you leave the spa unused for a long period of time in severely cold weather, you should drain the spa and winterize it to avoid accidental freezing due to a power or equipment failure.

⚠ DANGER: Use only Propylene Glycol as your anti-freeze (available at most RV or marine supply stores). This is non-toxic. Never use an automobile anti-freeze (Ethylene Glycol) since it is toxic!

Warning: Failure to follow these instructions correctly can lead to freeze damage not covered by warranty. It is strongly recommended that you contact your local dealer to perform this service

1. Drain your spa following the Drain & Refill instructions steps 1-8. Open the waterfall valve.
2. Remove the filter cartridges, clean and store in a dry place.
3. Remove wireless remote from spa and store in a dry warm place.
IMPORTANT: These additional instructions must be utilized when draining and winterizing your spa in climates where the temperature falls below 0°C (32°F). A 20 liter (5 gallon) combination (vacuum/blower) wet/dry shop vac must be used to effectively remove water that is trapped inside the plumbing lines.
4. Attach the vacuum's hose to the blower side of the shop vac.
 - a) Remove the filter standpipes by turning them counterclockwise. (The standpipes may have a silicone sealant temporarily holding them in place and it may take firm pressure to get them to initially break free.)
 - b) Place the end of the vacuum hose in one of the filter openings and cover the closest filter opening with a clean rag.
 - c) Turn on the blower function and allow it to blow out any water remaining in the plumbing lines (approximately 3 to 5 minutes).
 - d) Turn the **SMARTJET** lever to the second position and allow that system to purge.
 - e) If your spa is equipped with more than two jet systems, then each jet system will also need to be blown out.

5. Attach the vacuum hose to the vacuum side of the shop vac. Vacuum all openings and orifices as follows:
 - a) Jet openings: start with the jets at the top and move downward (if suction is coming from another jet, block off the other jet using a large rag – this will help pull out the water that is trapped deeper inside the main line).

- b) **BELLAFONTANA** water feature, if applicable (plug 2 openings and use the shop vac to pull water from the 3rd opening).
 - c) Filter compartment and **MOTO-MASSAGE DX** niche, if applicable (removal of the faceplate may be necessary).
 - d) Main drain outlet (it may be necessary to cover the drain grate tightly with a rag when vacuuming the main drain and secondary freeze drain outlets to ensure water is drawn completely from the internal plumbing system).
 - e) Secondary drain outlet and allow it to draw any remaining water from the spa's bleedlines (approximately 3 to 5 minutes).
6. Thoroughly dry the spa shell with a clean towel.
 7. Replace the main and secondary drain caps.

⚠ DANGER: Use only Propylene Glycol as your anti-freeze. This is non-toxic. **NEVER USE** an automobile anti-freeze (Ethylene Glycol) since it is toxic!

8. Using a long-extension funnel, pour anti-freeze into all standpipes, filter suction fittings, jet orifices and *BellaFontana* orifices. Add enough anti-freeze to ensure adequate protection – in many cases, you will see the liquid in the orifice, or coming out of another location. Re-install the filter standpipes if removed.
9. Close the spa cover and fasten the cover tie downs. Cover the spa cover with two pieces of plywood to evenly distribute the weight of snow and ice. Secure a plastic sheet, or tarp, over the spa cover and plywood.
10. Replace the equipment access door, if removed.

OPENING INSTRUCTIONS:

1. Remove plywood and plastic sheet. Open the spa cover by unfastening the cover tie downs.
2. Open drain to remove anti-freeze. Replace drain cap.
3. Follow the Start-up Procedures in the Quick Start-Up instructions section of the Owner's Manual. Do not install filters to prevent them from exposure to the anti-freeze.
4. As part of this process, superchlorinate the spa water by adding three teaspoons of chlorine (sodium dichlor) per 950 liters (250 gallons) of spa water into the filter compartment. This is twice the normal amount of chlorine needed for superchlorination. This extra amount of chlorine is needed to destroy the anti-freeze. A defoamer may be needed to decrease the amount of foam caused by the anti-freeze.
5. Drain your spa to ensure removal of anti-freeze. Do not drain water on grass or plants due to excessive chlorine level.
6. After the spa has completely drained, re-install your filters and follow the Start-up Procedures in the Quick Start-Up instructions of the Owner's Manual.

IMPORTANT: Always keep spa covered when not in use, whether it is empty or full.

FILTER SYSTEM

HOT SPRING spas are equipped with balanced filtration, meaning that the filter cartridges are sized to meet the needs of the jet pump system. Additionally, a separate filter is dedicated to serving the 24-hour circulation system.

As with any water filtering system, the filter cartridges may become clogged, resulting in reduced water flow. It is important to maintain a clean, unobstructed filtering system. This not only provides the maximum performance from the jets, but allows the 24 hour filtration system to function effectively. Rotating the placement of the filter

cartridges within the filter compartment after each cleaning will help to extend their service life.

IMPORTANT: The frequency and duration of use, and the number of occupants all contribute to determining the appropriate time between filter cleanings. More use means that more frequent filter cleanings are required. Failure to maintain the cartridges in a clean, unobstructed manner will result in reduced water flow through the heater assembly that may cause the High-Limit Thermostat, Heater Thermal Cut-off or Circulation Pump Thermal Cut-off to trip. If this high-limit or thermal cut-off trip occurs during sub-freezing temperatures and goes unnoticed, the spa water may freeze. Any damage to the spa (due to freezing) caused as a result of poor maintenance (stated under misuse or abuse in the **HOT SPRING** spa Limited Warranty), will not be covered by your spa warranty.

⚠ WARNING: To reduce the risk of injury to persons using the spa, DO NOT remove the suction fittings (filter standpipes) located in the filter compartment and do not sit on the filter lid, in extreme cases the lid could crack and break. This occurrence is considered abuse and is not covered under warranty.

FILTER CARTRIDGES REMOVAL & CLEANING

1. Disconnect the spa from the power supply by tripping the breakers located in the subpanel. Remove and carefully set aside the filter compartment cover.
2. Remove any floating items from within the filter compartment.
3. Turn the filter retainer handle (located on the top of the filter cartridge) counterclockwise until the retainer can be removed from the filter standpipe.
4. Remove the filter retainer and cartridge.
IMPORTANT: Never remove the filter standpipes when debris is present in the filter compartment. Debris may find its way into the internal plumbing which may result in blockage. **NEVER REMOVE SUCTION FITTINGS.**
5. Always clean standard filter using a filter degreaser, such as **HOT SPRING FRESHWATER** Filter Cleaner, to remove mineral and oil buildup. Simply soak the filter in the degreaser according to the package directions, then place the filter on a clean surface and spray until clean using a garden hose. It may be necessary to rotate the filter while spraying to remove any debris lodged between the filter pleats. The Tri-X™ filter can be cleaned in the dishwasher using no soap and no dry cycle. Please contact your **HOT SPRING** dealer for details.
6. To reinstall the filter cartridge, reverse the order of steps in which it was removed. Do not overtighten!

⚠ WARNING: Do not use the spa with the filter cartridges, or filter standpipe(s) removed!

CARE OF THE SPA PILLOWS

The spa pillows will provide years of comfort if treated with care. They have been positioned above the water level to minimize the bleaching effects of chlorinated water, and other spa water chemicals. To extend their life, whenever the spa shell is being cleaned, the spa pillows should be removed and cleaned. Body oils can be removed with a mild soap and water solution. ALWAYS rinse off the spa pillows thoroughly to remove any soap residue. The pillows can be conditioned with **HOT SPRING** Cover Shield after cleaning. If the spa is not going to be used for a long period of time (that is during a vacation, or if the spa is winterized), or when the spa water is being super-chlorinated, the spa pillows should be removed until the next spa use.

To remove and replace the spa pillows:

1. Carefully pull and lift on one end of pillow to stretch pillow (longer) until the pillow is released from the plastic retainer. Once one end is released, push pillow in opposite direction to remove from other retainer.
2. Align pillow by locating the arrow on back side of pillow and facing the arrow upwards.
3. Slide one end of pillow onto the spa retainer.
4. Pull other end of pillow; using both hands lift pillow above retainer and with a stretching motion slide pillow recess onto retainer.

CARE OF THE EXTERIOR

SPA SHELL

Your **HOT SPRING** spa has an acrylic shell. Stains and dirt generally will not adhere to your spa's surface. A soft rag should easily remove most dirt. Most household chemicals are harmful to your spa's shell (see below for detailed information on cleaning agents). Always rinse off any spa shell cleaning agent with fresh water.

IMPORTANT:

1. The following products are the **ONLY** approved cleaning agents for your **HOT SPRING** spa shell: plain water, **HOT SPRING FRESHWATER** Spa Shine, or Soft Scrub[®]. The use of alcohol or any other household cleaner other than those listed to clean the spa shell surface is **NOT** recommended. **DO NOT** use any cleaning products containing abrasives or solvents since they may damage the shell surface, specifically: Simple Green[®], Windex[®] or Spa Mitt. **NEVER USE HARSH CHEMICALS!** Damage to the shell by use of harsh chemicals is not covered under the warranty. Always rinse off any spa shell cleaning agent with fresh water.
2. Iron and copper in the water can stain the spa shell if allowed to go unchecked. Ask your **HOT SPRING** dealer about a Stain and Scale Inhibitor to use if your spa has a high concentration of dissolved minerals. (Watkins recommends **FRESHWATER** Stain & Scale Defense.)
3. Keep all cleaners out of the reach of children and use care when applying.

SPA CABINET

HOT SPRING spas include a spa cabinet made from a rigid polymer for durability and adds a finish that provides a rich, attractive appearance.

Cleaning of the cabinet consists of simply spraying the cabinet with a mild soap and water solution to remove any stains and residue.

Do not rub the cabinet with abrasive materials or use abrasive cleaners as this may damage its surface.

CARE OF THE SPA COVER

⚠ WARNING: The cover is a manual safety cover that meets or exceeds all prevailing requirements of ASTM 1346-91 for spa safety covers when installed and used correctly as of the date of manufacture. Non-secured, or improperly secured covers are a hazard.

Open the cover to its fully open position before use.

VINYL COVER

The vinyl spa cover is an attractive, durable foam insulation product. Monthly cleaning and conditioning are recommended to maintain its beauty.

To clean and condition the vinyl cover:

1. Remove the cover from the spa and gently lean it against a wall or fence.
2. With a garden hose, spray the cover to loosen and rinse away dirt or debris.
3. Using a large sponge and/or a soft bristle brush, and using a very mild soap solution (one teaspoon dishwashing liquid with 7.5 liters [2 gallons] of water), or baking soda (sodium bicarbonate), scrub the vinyl top in a circular motion. Do not let the vinyl dry with a soap film on it before it can be rinsed clean.
4. Scrub the cover's perimeter and side flaps. Rinse clean with water.
5. Rinse off the underside of the cover with water only (use no soap), and wipe it clean with a dry rag.
6. To condition the cover after cleaning, apply a thin film of **HOT SPRING** Cover Shield to the vinyl surface and buff to a high luster.

IMPORTANT: To remove tree sap, use cigarette lighter fluid (not charcoal lighter fluid). Use sparingly, and rinse with a saddle soap solution immediately afterwards, then wipe dry.

DO:

- Remove snow buildup to avoid breakage of the foam core from the additional weight of the snow.
- Lock cover lock straps to secure the cover when the spa is not in use.

DON'T:

- Drag or lift the spa cover using either the flaps, or the cover lock straps.
- Walk, stand, or sit on the cover.
- Place any metal or heat transferring object on the cover or place any type of plastic tarp or drop cloth over the cover as this may result in a melted foam core, which would not be covered under the warranty.
- Use any lifting mechanisms, chemicals, or cleaners except those recommended by **WATKINS WELLNESS**, or its Authorized Sales and Service Dealer.

COVER LIFTER SYSTEM

Clearance required behind cover when open:

CoverCradle™ & COVERCRADLE II 61 cm (24")	UpRite™ 18 cm (7")	Lift 'n Glide™ 36 cm (14")
--	-----------------------	-------------------------------

HOW TO OPEN THE VINYL COVER

IMPORTANT: Never attempt to open or remove the vinyl cover by grasping or pulling on the skirting or cover lock straps. The skirting will tear, and torn skirting is not covered under the terms of the warranty.

Check for ice build-up around the gas springs and pivot points of the retractable cover system. Ice buildup may damage system components.

⚠ WARNING: The vinyl cover and retractable cover system are not recommended for use in wind conditions reaching above 40 kmh (25 mph).

IMPORTANT: If your spa is located in an area susceptible to high winds, additional coverlock straps may be installed to minimize wind damage to the cover.

1. With the cover lock straps unfastened, place one hand under the cover skirting, between the spa and cover, to break the cover's vacuum seal. Then, fold the front half of the cover over onto the back half.
2. If no rear access is available, stand to the side of the spa directly adjacent to the hinge area of the folded cover.
 - a) **For the COVERCRADLE retractable cover systems:** Using both hands, cup one hand under the lower half of the cover (just above the water) and place the other along the side of the cover, just above the skirt. Gently push (do not lift) with both hands towards the opposite rear corner of the cover (diagonally). As the cover opens, the gas springs will allow the cover to come to a gentle stop.
 - b) **For the UPRITE retractable cover system:** Simply lift the cover at its center hinge, allowing it to move to the back of the spa and to rest gently there.
 - c) **For the LIFT 'N GLIDE retractable cover system:** Slightly lift the cover at front of spa, glide (push back until it stops), fold cover in half and lift cover moving it to the back of the spa. Insert locking pin into side of lifter to prevent accidental closure.

IMPORTANT: When opening a cover with a retractable cover system, only use one of these three specific methods. Do not attempt to open the cover in any other way. Damage caused by improper opening or closing of the cover is not covered under the terms of the limited warranty.

HOW TO CLOSE THE COVER

1. Standing alongside the cover, place one hand on the upper corner of the cover and gently push forward in the direction of the spa. The cover will rotate forward to cover half of the spa.
IMPORTANT: For the UPRITE or LIFT 'N GLIDE retractable cover system, disengage the locking mechanism(s) before pushing the cover forward.
2. Unfold the cover by lifting the handle located on the top (front) half of the cover. Allow the unfolded half to fall down onto the spa. The air pressure created by the cover falling will keep the vinyl skirting from being trapped between the cover and the spa shell.

ELECTRICAL REQUIREMENTS

INSTALLATION

IMPORTANT: Fill the spa with water before turning on the power.

Your **HOT SPRING** spa has been carefully designed to give you maximum safety against electrical shock. Connecting the spa to an improperly wired circuit will negate many of the spa's safety features. Improper wiring may also cause electrocution, risk of fire, and other risks of injuries. Please read and follow the electrical installation requirements and instructions for your specific spa model completely!

All **HOT SPRING** spa models, are equipped with a power indicator (**HOT SPRING** Logo blue light) which, in addition to showing the spa has power to it, has a diagnostic function as well. It will begin blinking if the heater high-limit thermostat has tripped. If the power indicator light is blinking, follow the instructions in the Troubleshooting section to identify and correct the cause. The power indicator will stop blinking once the problem has been corrected. The Power and Ready indicator lights on the control panel also provide the same diagnostic function.

HOT SPRING spas must be wired in accordance with all applicable local electrical codes. All electrical work should be done by an experienced, licensed electrician. We recommend the use of appropriate electrical conduit, fittings, and wire for all circuits.

This product requires a 16 amp or 20 amp single phase, 230 volt, three wire service (one line, one neutral, one ground) depending on your spa, see page 48 for spa specific information. The grounding conductor must be at least the same gauge as the line conductors, but no smaller than 2.10 mm² (4.0 mm² for 20 amp models). A minimum 6 mm² solid copper bond may also be required. Additionally, one main disconnect switch with at least 3 mm separation between contacts must be used for all electrical circuits to the spa.

Mount the subpanel according to local codes, but not closer than 1.5 m (5') away (follow your local codes).

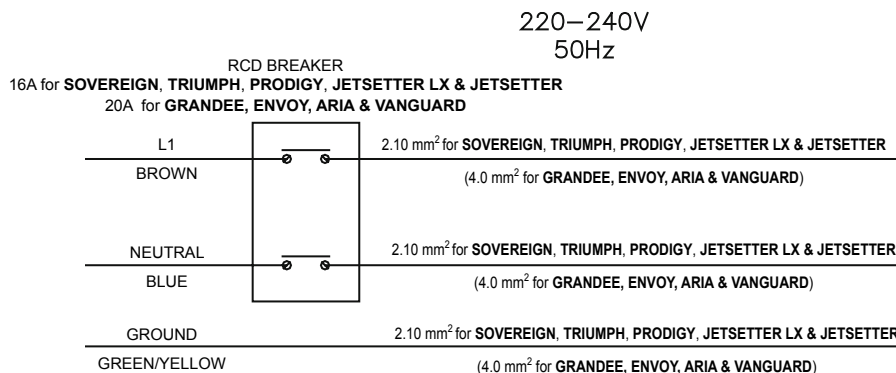

CONDUIT INSTALLATION INSTRUCTIONS

- To connect the electrical service, first detach the equipment compartment door as follows:
 - See page 47 for Door Removal Instructions
 - Slide each of the 3 clips to the left and lower clip (if clip doesn't slide, slightly loosen the 2 screws holding the clip).
 - Lower door panel, remove connector from back side of door attached to the Logo light, remove door panel.
- Locate the control box. Loosen the screws on the front of the control box. Remove the screws and the control box cover.
- Route the electrical through the access opening on either side of the spa towards the front (bottom) and into the equipment compartment.
- Connect the supply conduit to the control box and connect the wiring as detailed below or on the wiring diagram label on the inside of the control box cover. Once completed, replace control box cover.
- To replace equipment compartment door, reverse the procedure found in step 1.

SERVICE NOTE: All **HOT SPRING** spa models are equipped with a power-on indicator which, in addition to showing the spa has power to it, has a diagnostic function as well. It will begin blinking if the heater high limit thermostat has tripped.

IMPORTANT NOTICE: Your spa must be supplied by a ground fault circuit interrupter - residual current device (RCD) - with a tripping rating not exceeding 30 mA in an electrical subpanel.

Because of varying receptacle conditions in each country, **WATKINS WELLNESS** DOES NOT supply this device as a standard part of the spa. It is the sole responsibility of the Authorized Watkins Dealer to select, install and confirm the functioning condition of this device. **WATKINS WELLNESS** recommends this device be attached to the end of the spa's electrical cord. The RCD must be installed by a licensed, qualified electrician. RCD devices must meet or exceed all national and local electrical codes.

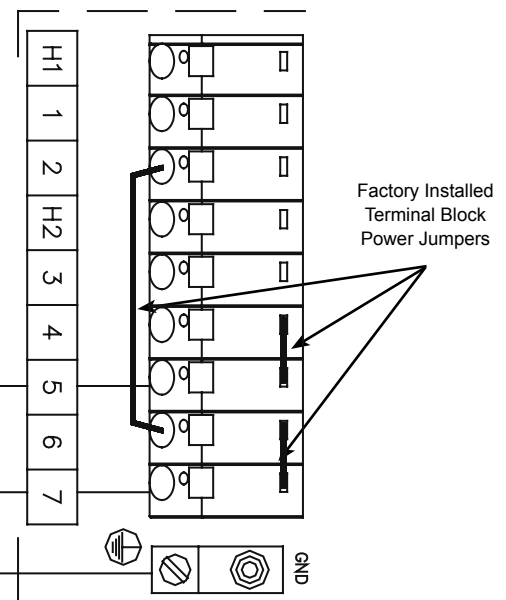

INSTALLATION INSTRUCTIONS

SITE PREPARATION

You probably have a spot picked out for your new spa, whether it's indoors or outdoors, on a patio or on a deck. Just make sure you check the following:

- Always put your spa on a structurally sound, level surface. A filled spa can weigh a great deal. Make certain that the location you choose can support the weight.
- Don't forget to level your spa before filling it. (See Spa Leveling Instructions.)
- Be sure to locate your equipment compartment, which houses all of the electrical components, in a place where water drainage will be away from it. Allowing water into the equipment compartment can cause damage to the electronics, or may result in tripping the circuit breaker on your house's electrical panel.
- Leave yourself easy access to the circuit breakers.
- Leave access to the equipment compartment for periodic spa care and maintenance.

⚠ **WARNING: Damage to the spa's equipment compartment components or internal plumbing as a result of rodent infestation is NOT covered under your warranty!**

OUTDOOR AND PATIO INSTALLATION

No matter where you put your new spa, it's important that it has a solid foundation to support it. In fact, structural damage to the spa, resulting from incorrect installation, or placement on an inadequate foundation, is not covered under the spa's limited warranty.

If you install the spa outdoors, we recommend a reinforced concrete pad at least ten centimeters thick. The reinforcing rod or mesh in the pad should be attached to a 6 mm² bonding wire per national electrical codes (contact your local electrical code compliance inspector for more information; inspection for proper grounding may be required before pouring concrete to form the slab).

If you place the spa on the ground, even temporarily, place stepping stones under the leveling areas (see Spa Leveling Instructions). Even with stones in place, the spa will inevitably settle and become unlevel. Plus, a spa surrounded by dirt or grass will soon be filled with dirt or grass from users' feet. So get it onto a solid foundation as soon as possible.

DECK INSTALLATION

To be certain your deck can support your spa, you must know the deck's maximum load capacity. Consult a qualified building contractor or structural engineer. To find the weight of your spa, its contents and occupants, refer to the Spa Specification chart. This weight per square meter must not exceed the structure's rated capacity, or serious structural damage could result.

CAUTION: WATKINS WELLNESS suggests a structural engineer or contractor be consulted before the spa is placed on an elevated deck.

INDOOR/BASEMENT INSTALLATION

Be aware of some special requirements if you place your spa indoors. Water will accumulate around the spa, so flooring materials must provide a good grip when wet. Proper drainage is essential to prevent

a build-up of water around the spa. When building a new room for the spa it is recommended that a floor drain be installed. The humidity will naturally increase with the spa installed. Water may get into woodwork and produce dry rot, mildew, or other problems. Check for airborne moisture's effects on exposed wood, paper, etc. in the room. To minimize these effects, it is best to provide plenty of ventilation to the spa area. An architect can help to determine if more ventilation must be installed.

HOT SPRING spas are equipped with a vent to remove excessive heat from the equipment compartment. Find this vent (its under the bottom front left or right corner) and be sure the vent is not blocked by anything, including carpeting.

Your **HOT SPRING** dealer can help you with local information such as zoning regulations and building codes. They can also give you a copy of our planning guide.

CAUTION: Do not install the spa on a heated floor.

⚠ **WARNING: Please keep the area around your spa well ventilated when it is installed indoors or in a confined area.** Inadequate ventilation around the spa could cause a build-up of a higher-than-normal concentration of spa chemicals and/or bacterial fragments. These dispersed spa chemicals and/or bacterial fragments can be inhaled, and may result in breathing difficulties or lung damage in certain people suffering from a compromised immune system or respiratory infection. If you or other bathers are affected by this condition, please seek medical attention as soon as possible.

In addition to the above, properly clean and maintain your spa as follows:

- Follow all procedures in this owner's manual and printed instructions on all water care (chemical) products packaging.
- Test the water regularly to ensure proper levels of sanitizers, pH, and other water care requirements.
- Drain, clean, and refill your spa with fresh water on a regular schedule, and in accordance with this owner's manual.
- Clean the filter(s) at least once per month.
- Check to make sure you have proper circulation throughout your spa water system.
- Have spa users bathe before entering the spa water.

SPA LEVELING PREPARATION

Concrete sloped at 1.5 cm (.5") per 3.5 m (10') is preferred so that rain water and water spillover will run off and not puddle underneath the spa

(water under the spa for long periods of time may cause the wood to deteriorate). Other options are brick, stepping stone, or blocks.

It is important to note that soft surfaces, even when stepping stones are used to evenly distribute the weight of the spa, will have a tendency to settle, thus resulting in an unlevelled spa.

NOTE: Placing the spa on grass or dirt may increase the amount of debris which is inadvertently brought into the spa water and may cause harm to your equipment as well as the spa surface, which is not covered under warranty.

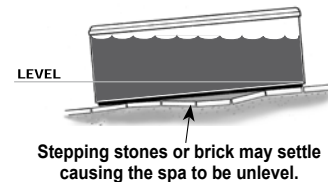
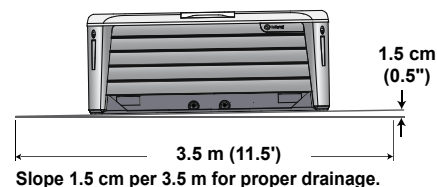

SPA LEVELING INSTRUCTIONS

In order for your **HOT SPRING** spa to operate properly, and the internal plumbing to drain completely, the spa must be level.

⚠ **WARNING: WATKINS WELLNESS** recommends that a structural engineer or contractor be consulted prior to placing the spa on an elevated deck, or platform. Use the Dead Weight in the Spa Specification chart to determine the structure's requirements.

IMPORTANT: WATKINS WELLNESS reserves the right to change any specifications or design without incurring any obligation.

Approved Shim Material

- Cedar shingles
- Exterior rated plywood
- Redwood
- Exterior rated lumber

The shims used should vary in thickness and should be cut into 5 cm (2") x 10 cm (4") rectangles.

NOTE: Due to the large size of the GRANDEE spa WATKINS WELLNESS requires the spa be installed on a level 10 cm (4") thick concrete pad or structurally engineered deck and NOT shimmed in any manner.

Leveling Instructions

1. Using a 2 m (6') carpenter's level (or a shorter level and a straight board 5 cm (2") by 10 cm (4"), 2.5 m (8') long), check the spa to identify the highest, and lowest corners.
2. With one end of the level resting on the highest corner of the spa (and the opposite end resting on the lowest corner), gently raise the lower end of the level by placing shims between the spa shell and the level, until the level itself is level. This will tell you how many shims are needed at that lowest corner.
3. Now carefully pivot the level, keeping the shimmed end where it is, until the other end of the level rests on one of the other corners. Check the level. Adjust the end of the level using the procedure above. Carefully pivot the level again to the last corner, leaving the pivot end at its original location, and repeat the procedure. Whatever shims are on the three corners are the ones you will place under those corners in the next steps.
4. Remove the level and set it aside. Carefully remove the shims and keep them together, remembering the corner from which each set of shims came.
5. With more than one person lifting, lift the lowest side of the spa (the one with the most shims), and place a 10 cm (4") x 10 cm (4") block under the spa pedestal, at the center of the side lifted.
6. Refer to the spa pedestal support diagram for your spa to locate the leveling points for the elevated corners. Place the set of shims corresponding to each corner directly under its designated leveling point.
7. Lift the spa, remove the support block, and set the spa on the shims. Repeat steps 5 through 7, if necessary, for the opposite side of the spa.
8. Use the level to check the level of the spa. Make any necessary adjustments.
9. Refer to the spa pedestal support diagram for your spa to locate the remaining leveling points, each of which must now also be shimmed, and carefully slide "helper" shims under the spa at their designated locations. These helper shims should create a snug fit between the foundation and the spa pedestal structure. If it is necessary to lift the spa in order to place the helper shims, use care not to kick out the original corner shims.

The following pages illustrate base support diagrams indicating the recommended shimming points.

NOTICE: Though designed for outdoor installation, your **HOT SPRING** spa is not impervious to damage that may be caused by insects, rodents, or other living creatures. A screen at the bottom of the spa's equipment compartment is designed to minimize their ability to access the equipment compartment and cause damage to the spa components. Please note, the electronics within the compartment need adequate airflow to cool the equipment and maintain the optimal temperature range. Sealing the opening completely, or allowing debris to build-up on the screen mesh, will adversely affect the spas' performance. Damage to the spa or its components caused by an "act of nature", rodent or insect damage is not covered under the terms of your spa's Limited Warranty.

DELIVERY ACCESS

First, locate the dimensions of your spa on the following chart. The dimensions shown are the measurements of the spa in the vertical position, laid on its side.

Model	W	L	H
GRANDEE (GGNE)	97 cm (38")	254 cm (8'4")	231 cm (7'7")
ENVOY (KKNE)	97 cm (38")	236 cm (7'4")	231 cm (7'7")
VANGUARD (VVNE)	91 cm (36")	221 cm (7'3")	221 cm (7'3")
ARIA (ARNE)	91 cm (36")	221 cm (7'3")	221 cm (7'3")
SOVEREIGN (IINE)	84 cm (33")	236 cm (7'4")	203 cm (6'8")
TRIUMPH (TRHNE)	84 cm (33")	236 cm (7'3")	188 cm (6'2")
PRODIGY (HNE)	84 cm (33")	213 cm (7'0")	198 cm (6'6")
JETSETTER LX (JTNE)	84 cm (33")	213 cm (7'0")	165 cm (5'5")
JETSETTER (JJNE)	74 cm (29")	213 cm (7'0")	165 cm (5'5")

Next, contact your dealer to find the height and width added by the delivery cart which the dealer will use to deliver your new spa. Use the height of the cart plus the dimension shown as H to determine the vertical clearance required to pass the spa and cart. Use the width of the cart, or dimension W, whichever is greater, to determine the maximum width of clearance necessary.

NOTE: It may be necessary to allow for additional over-head clearance if the spa will be rolled up or down an incline or moved up or down a short flight of stairs.

Use the information above to determine the requirements for access to your desired location.

It may be necessary to remove a gate, part of a fence, or other movable obstructions in order to roll the spa to its installation site.

If the spa has to be taken off the cart to go over a wall (either because the entry area is too narrow, the eaves are too low, the corner is too tight, or the stairway is too steep), a crane will be required. This is a common practice.

The crane has a truck-mounted boom which can fit right in your driveway. It must be run by a licensed and insured operator. For a

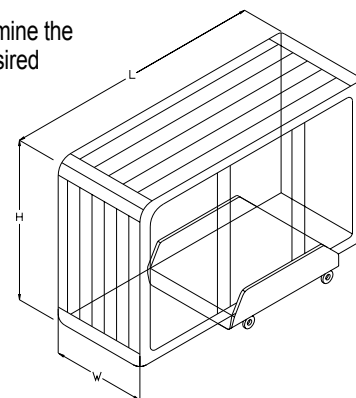

charge, the crane operator will lift your spa over walls, buildings, or any other obstruction and place it as close to the installation site as possible.

NOTE: If your spa delivery requires the use of a crane, you may be required to pay for its services at the completion of the delivery.

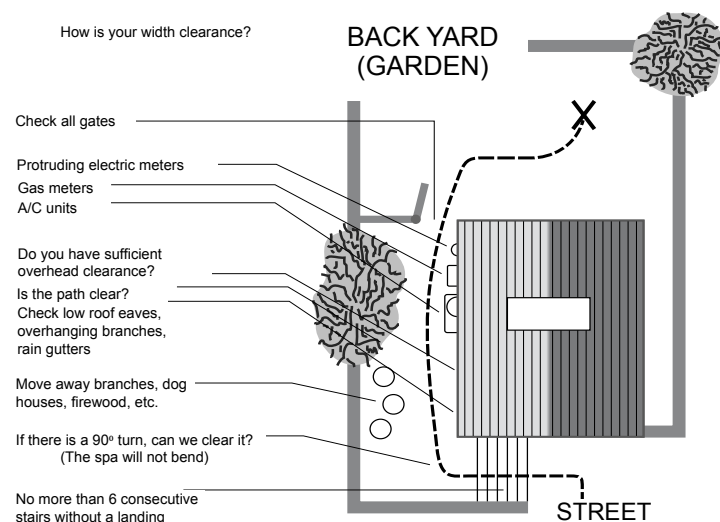

INSTALLATION NOTES:

- If stepping stones or railroad ties are selected for the spa foundation, they should be placed at the designated leveling areas of your spa to maintain even distribution of the spa weight.
- It is important to note that soft surfaces, even when stepping stones are used to evenly distribute the weight of the spa, will still have a tendency to settle, resulting in an unlevel spa.
- Remember, placing the spa on grass or dirt may increase the amount of debris which is inadvertently brought into the spa water on the user's feet.

If you are purchasing a deck package or a gazebo with your spa, a solid foundation is mandatory. Placing them on any surface other than a single level pad could create problems with their installation. As a homeowner, it is your responsibility to provide a suitable, level foundation for your spa. Keep in mind that most delivery crews are not equipped to level and prepare spa sites.

NOTE: In order for the spa to operate properly and the internal plumbing to drain completely, you must ensure that the spa is leveled after it has been installed. The diagrams on the following pages indicated the recommended shimming points on your spa's base support system. Your **HOT SPRING** delivery crew can help you perform the procedure.

GROUND PREPARATION

Your **HOT SPRING** spa has been engineered to perform on all kinds of common surfaces. While a concrete slab is best for long-term use*, other foundations are acceptable so long as a level base is prepared prior to delivery. Three foundation base pictures, shown at right, represent examples of alternatives to a concrete slab for spas installed without gazebos or other accessories.

*NOTE: A reinforced concrete pad at least 10 cm (4") thick is required for the **GRANDEE** spas, and recommended for the **ENVOY, ARIA, VANGUARD, SOVEREIGN, TRIUMPH, PRODIGY, JETSETTER LX & JETSETTER** spas.

GRANDEE

Dimensions

NOTE: All dimensions are approximate; measure your spa before making critical design or pathway decisions.

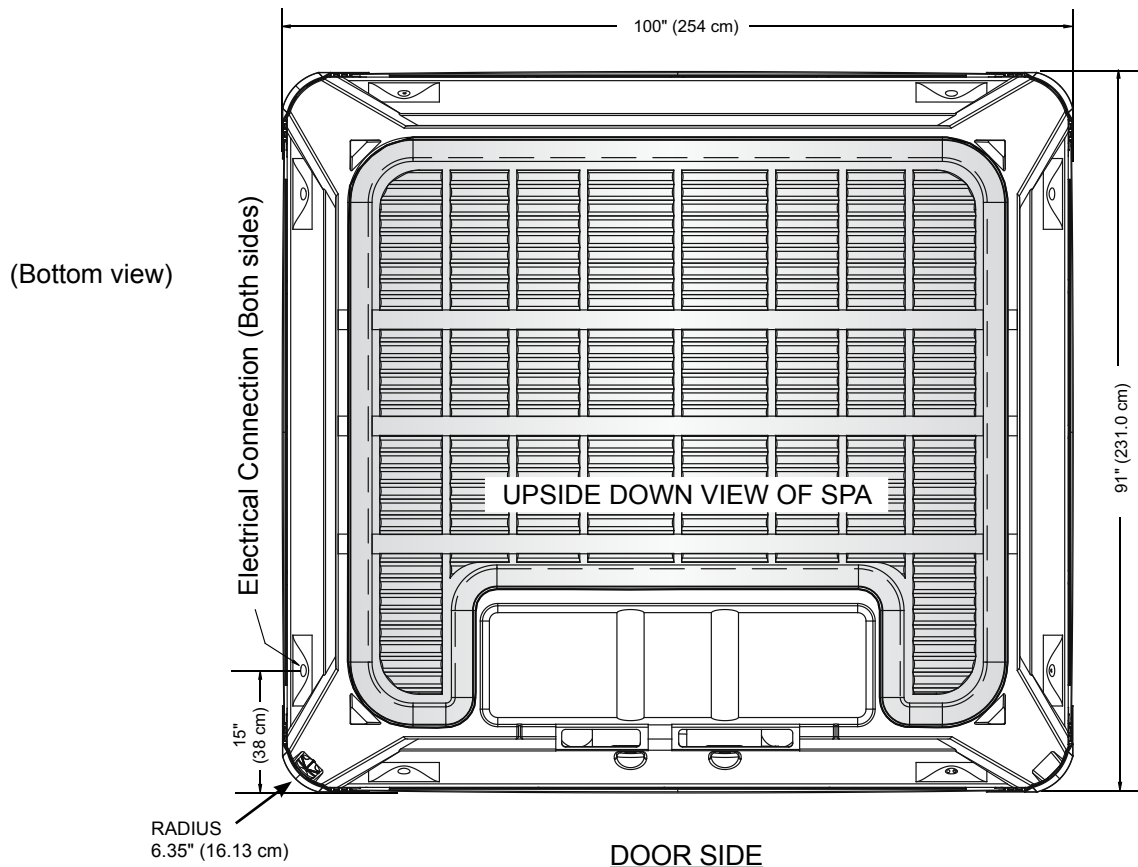
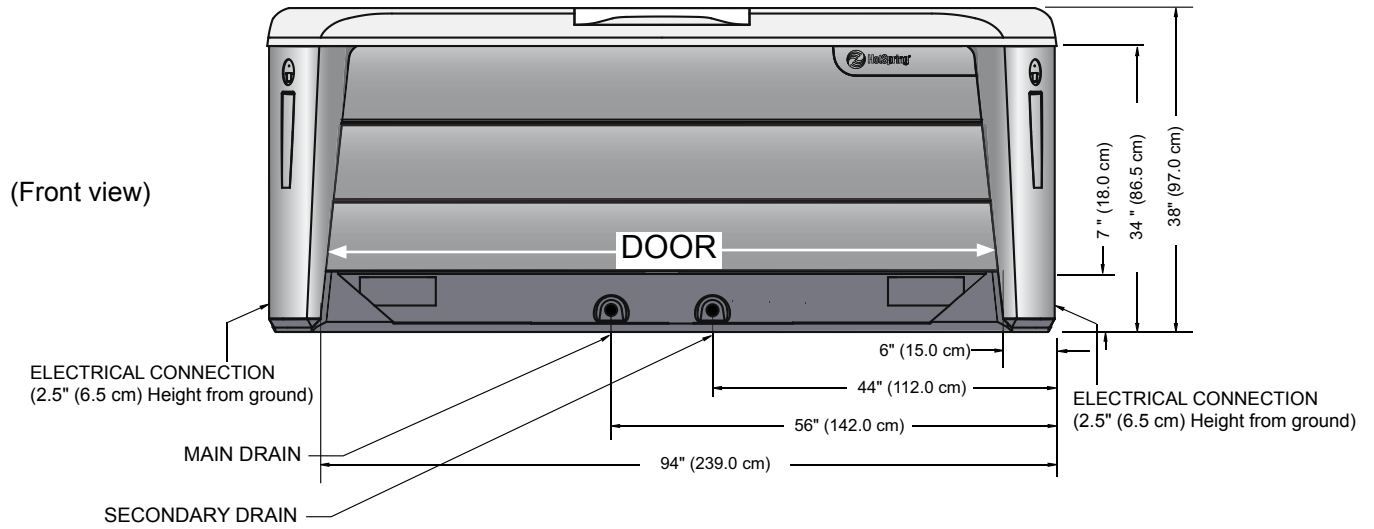

NOTE: WATKINS WELLNESS requires that the **GRANDEE** be installed on a minimum 10 cm (4") thick reinforced concrete pad or a deck that is able to withstand more than 555 kg/m² (125 lbs. per square foot).

WARNING: The **GRANDEE** must not be shimmed in any manner.

ENVOY

Dimensions

NOTE: All dimensions are approximate; measure your spa before making critical design or pathway decisions.

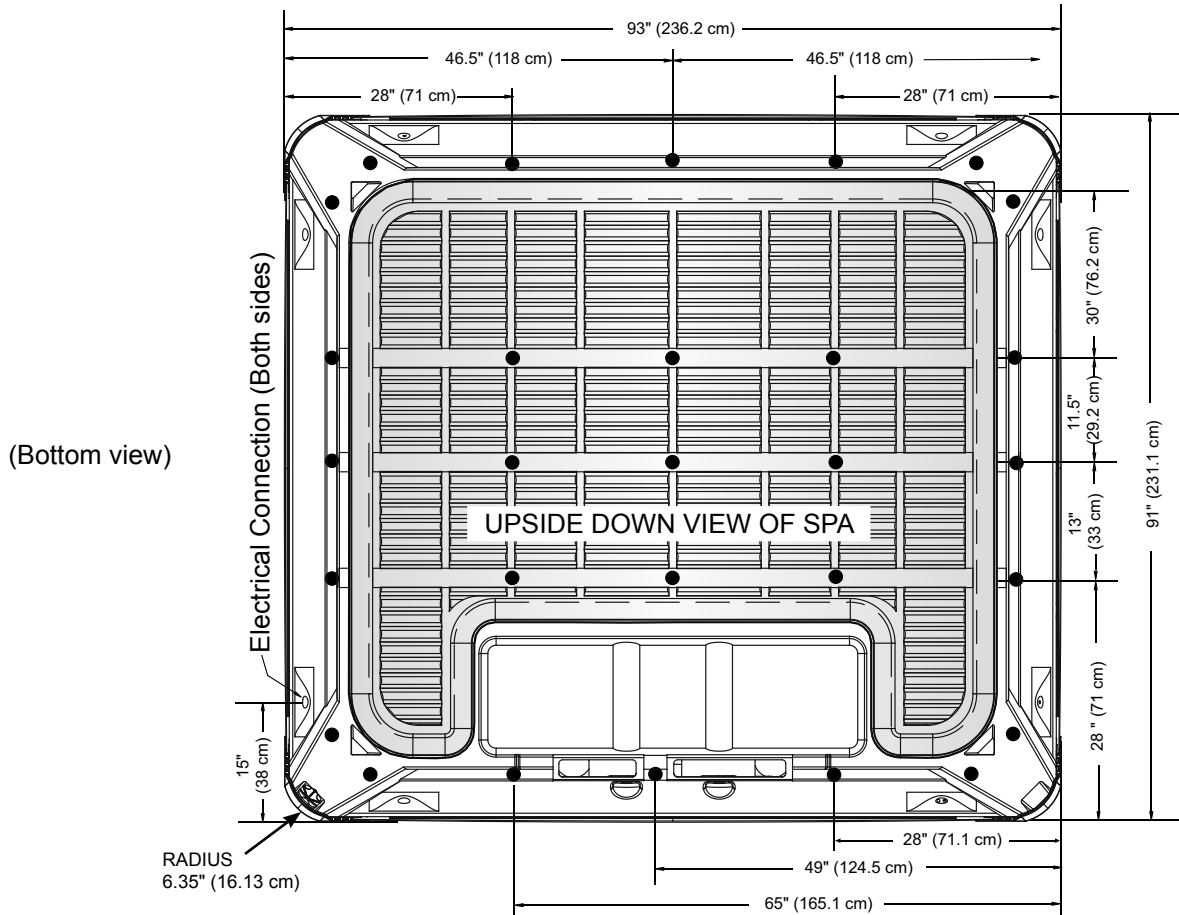
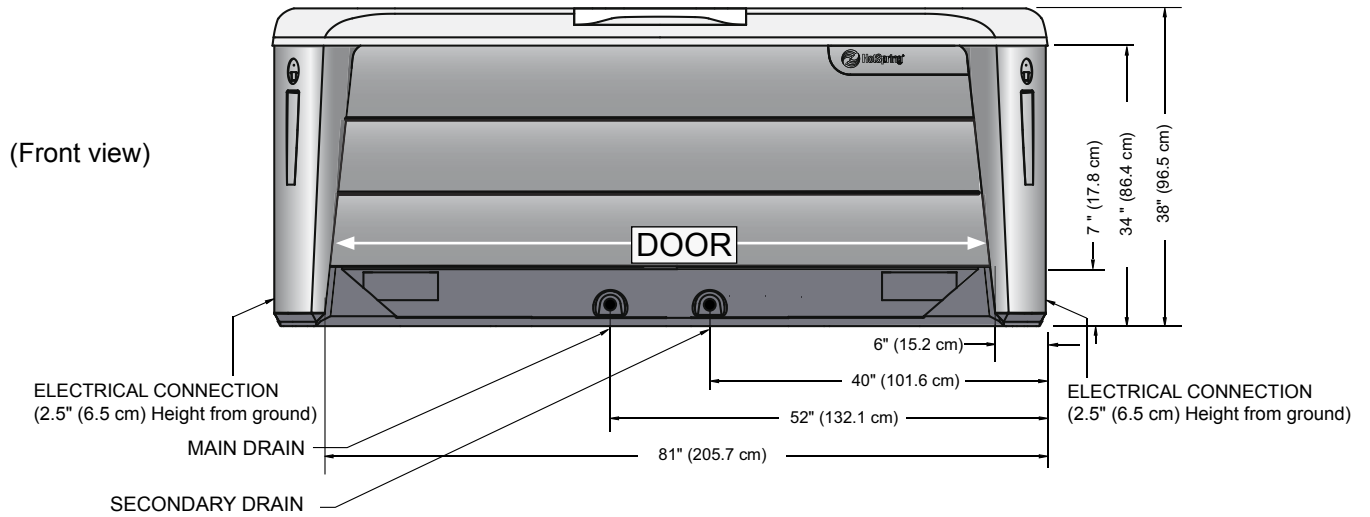

DOOR SIDE

● **IMPORTANT:** The ENVOY has 29 leveling points ● (place shims at illustrated locations)

VANGUARD

Dimensions

NOTE: All dimensions are approximate; measure your spa before making critical design or pathway decisions.

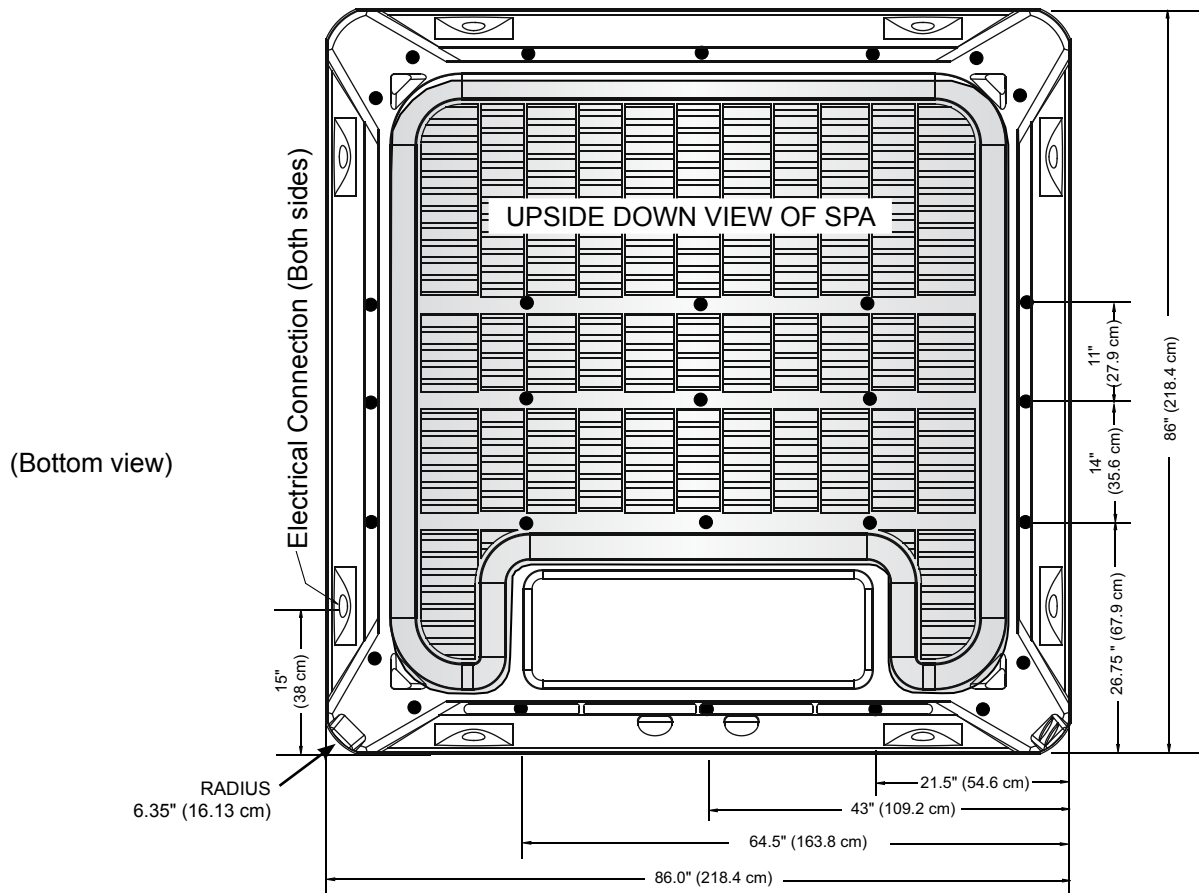
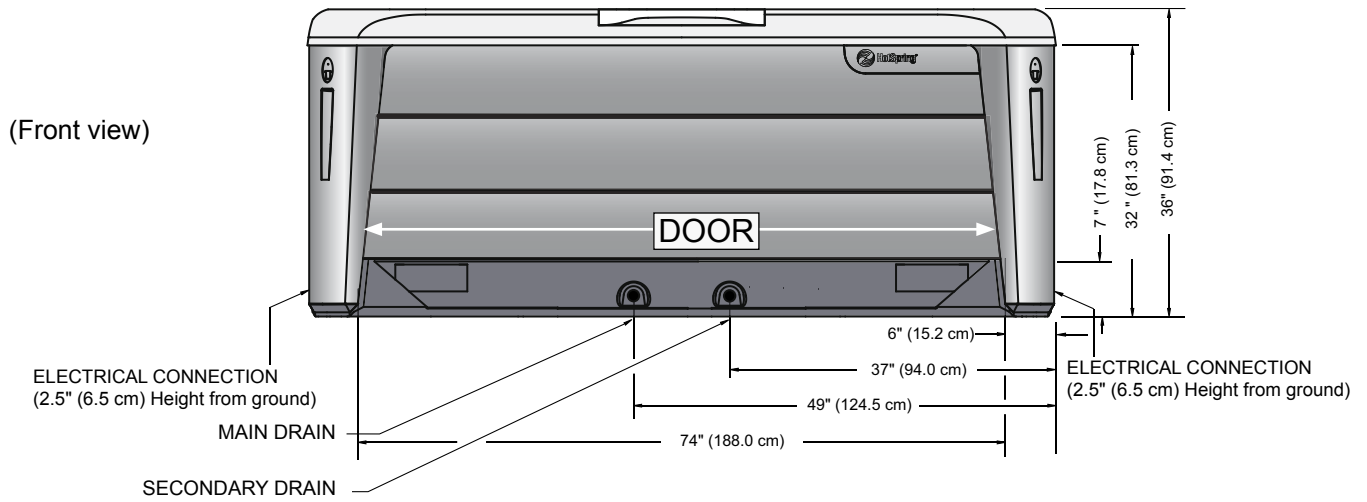

DOOR SIDE

● **IMPORTANT:** The VANGUARD has 29 leveling points ● (place shims at illustrated locations)

ARIA

Dimensions

NOTE: All dimensions are approximate; measure your spa before making critical design or pathway decisions.

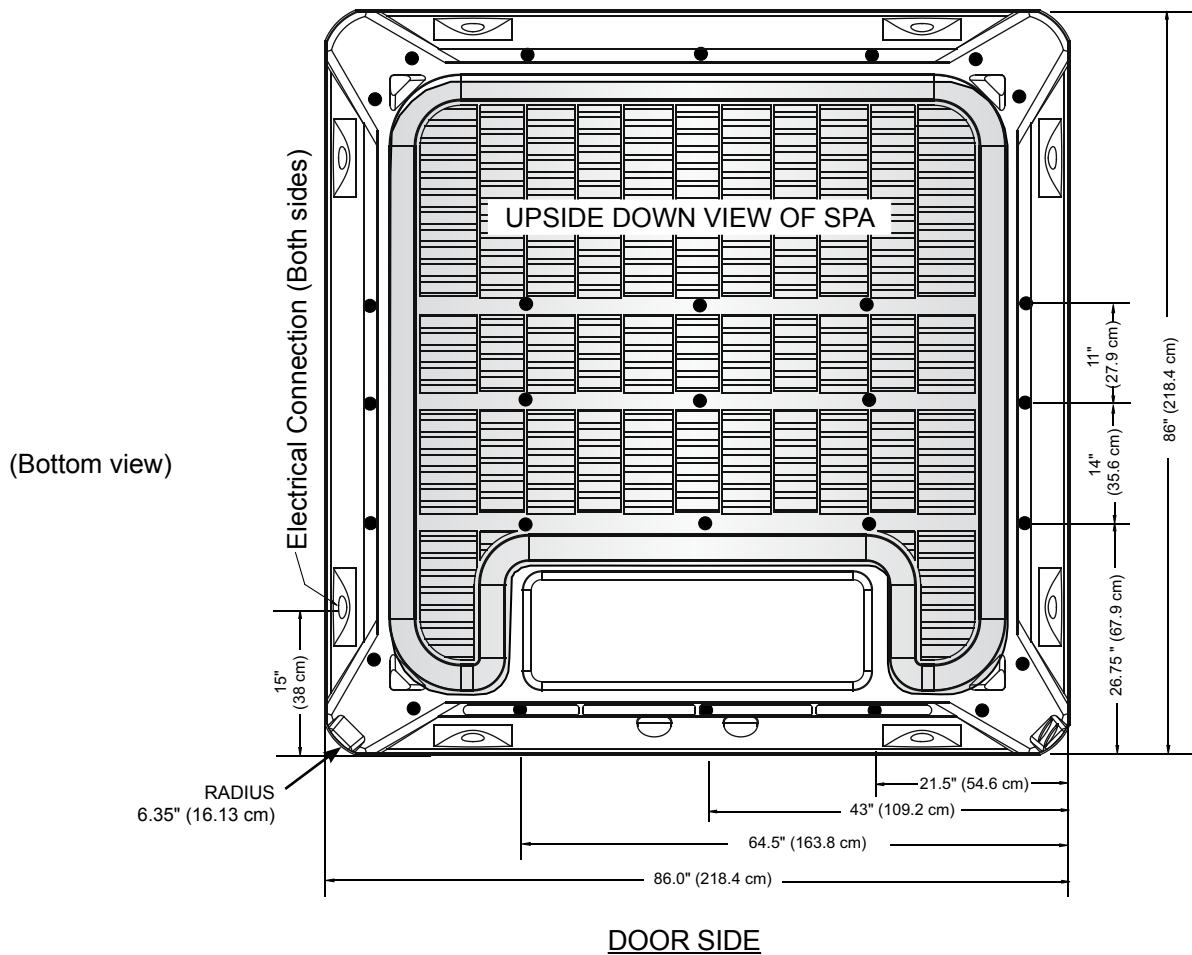
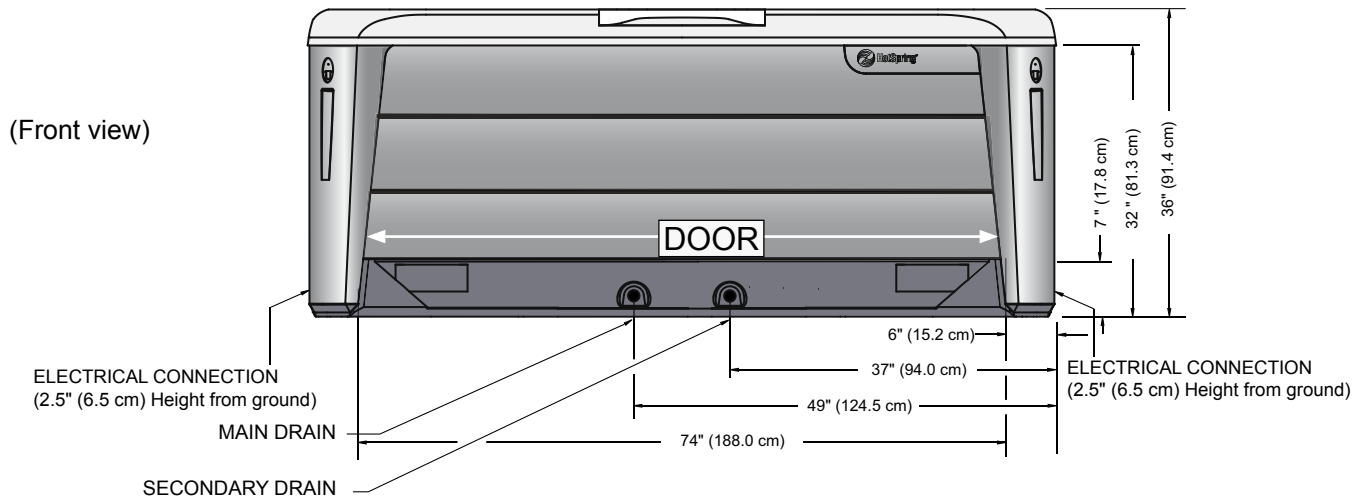

● **IMPORTANT:** The ARIA has 29 leveling points ● (place shims at illustrated locations)

SOVEREIGN

Dimensions

NOTE: All dimensions are approximate; measure your spa before making critical design or pathway decisions.

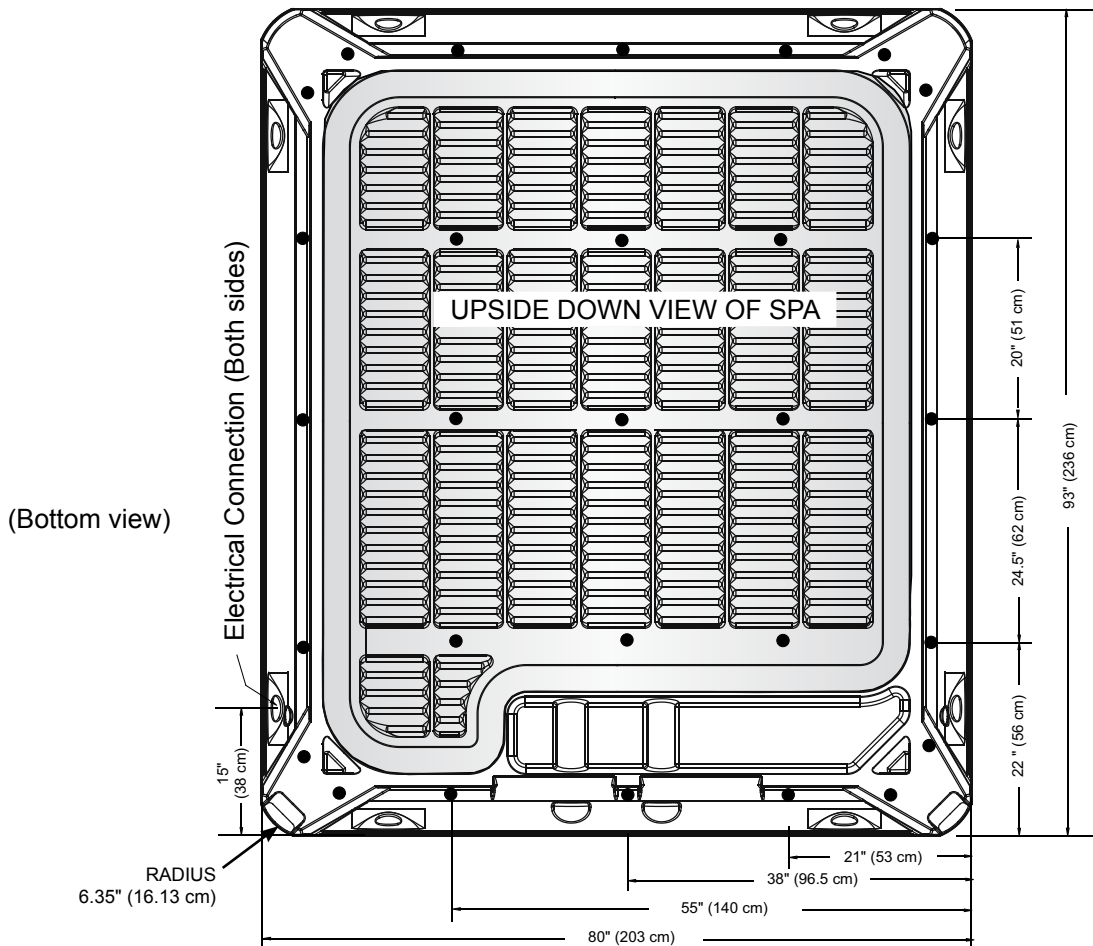
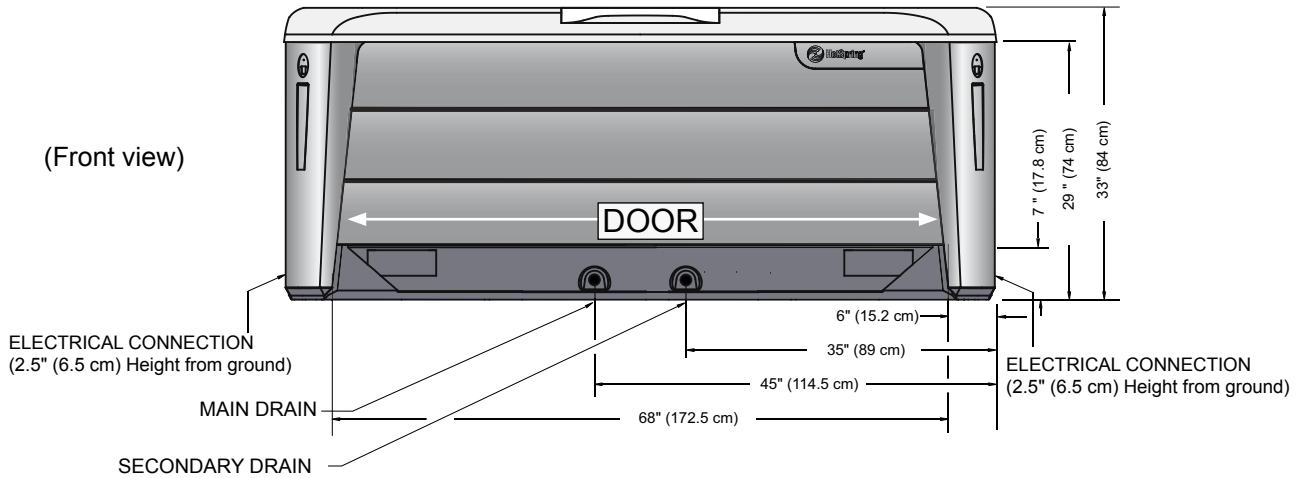

DOOR SIDE

● **IMPORTANT:** The **SOVEREIGN** has 29 leveling points (place shims at illustrated locations)

TRIUMPH

Dimensions

NOTE: All dimensions are approximate; measure your spa before making critical design or pathway decisions.

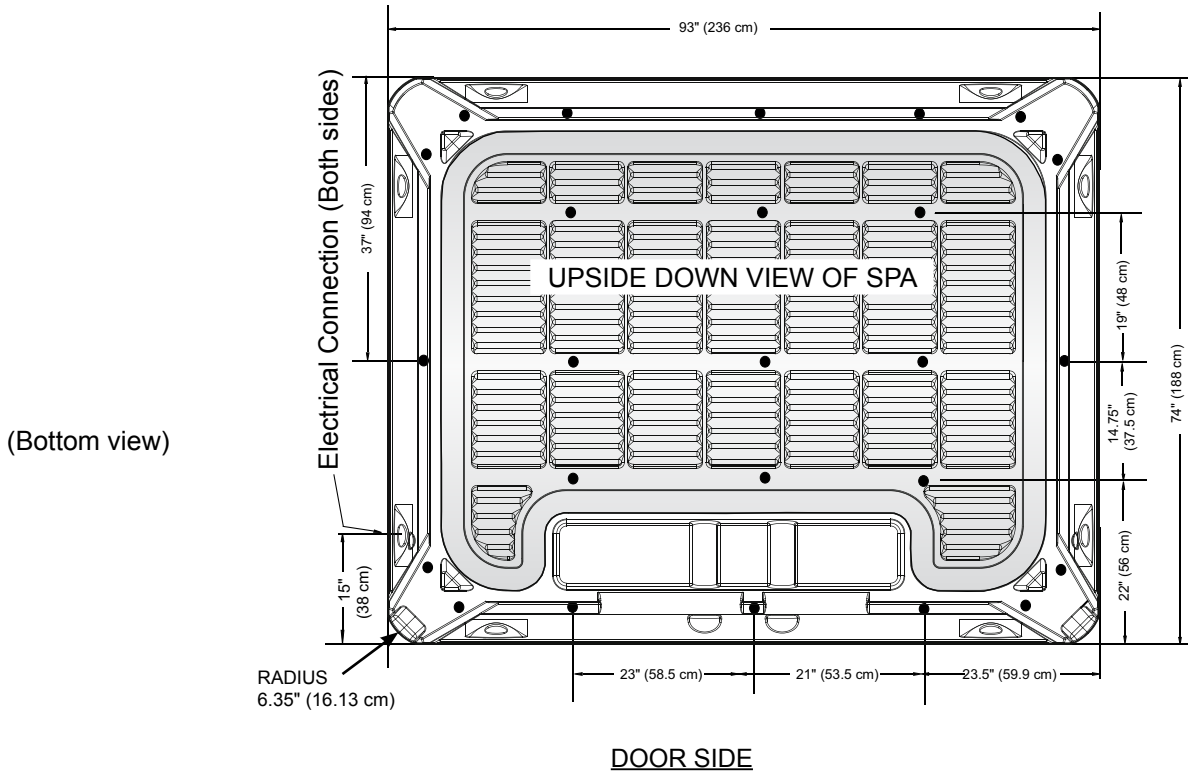
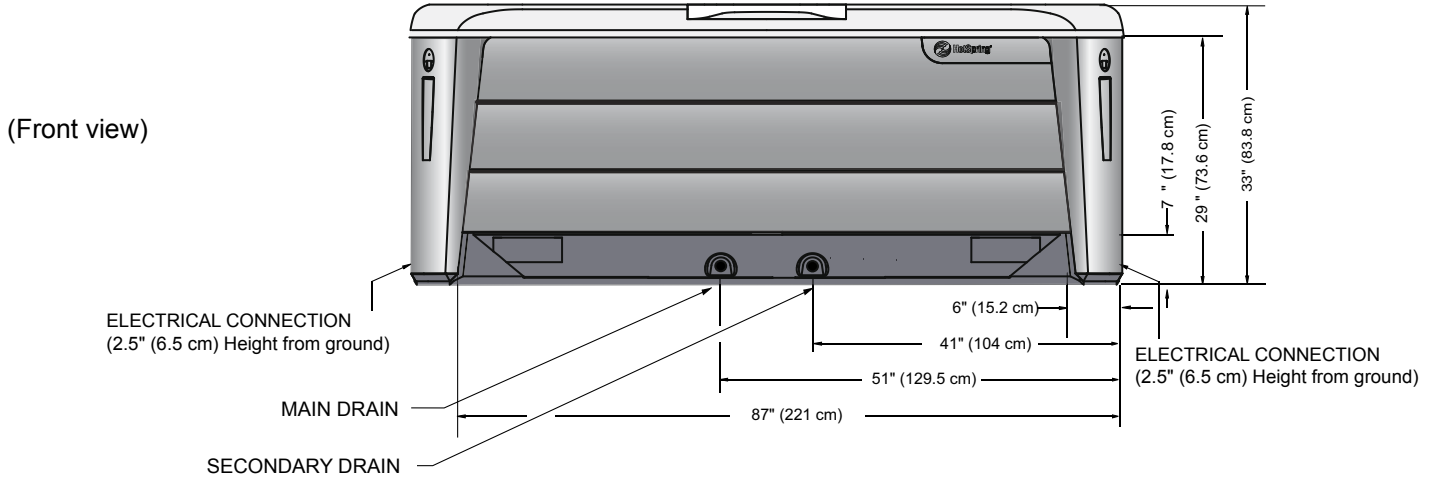

● **IMPORTANT:** The **TRIUMPH** has 25 leveling points (place shims at illustrated locations)

PRODIGY

Dimensions

NOTE: All dimensions are approximate; measure your spa before making critical design or pathway decisions.

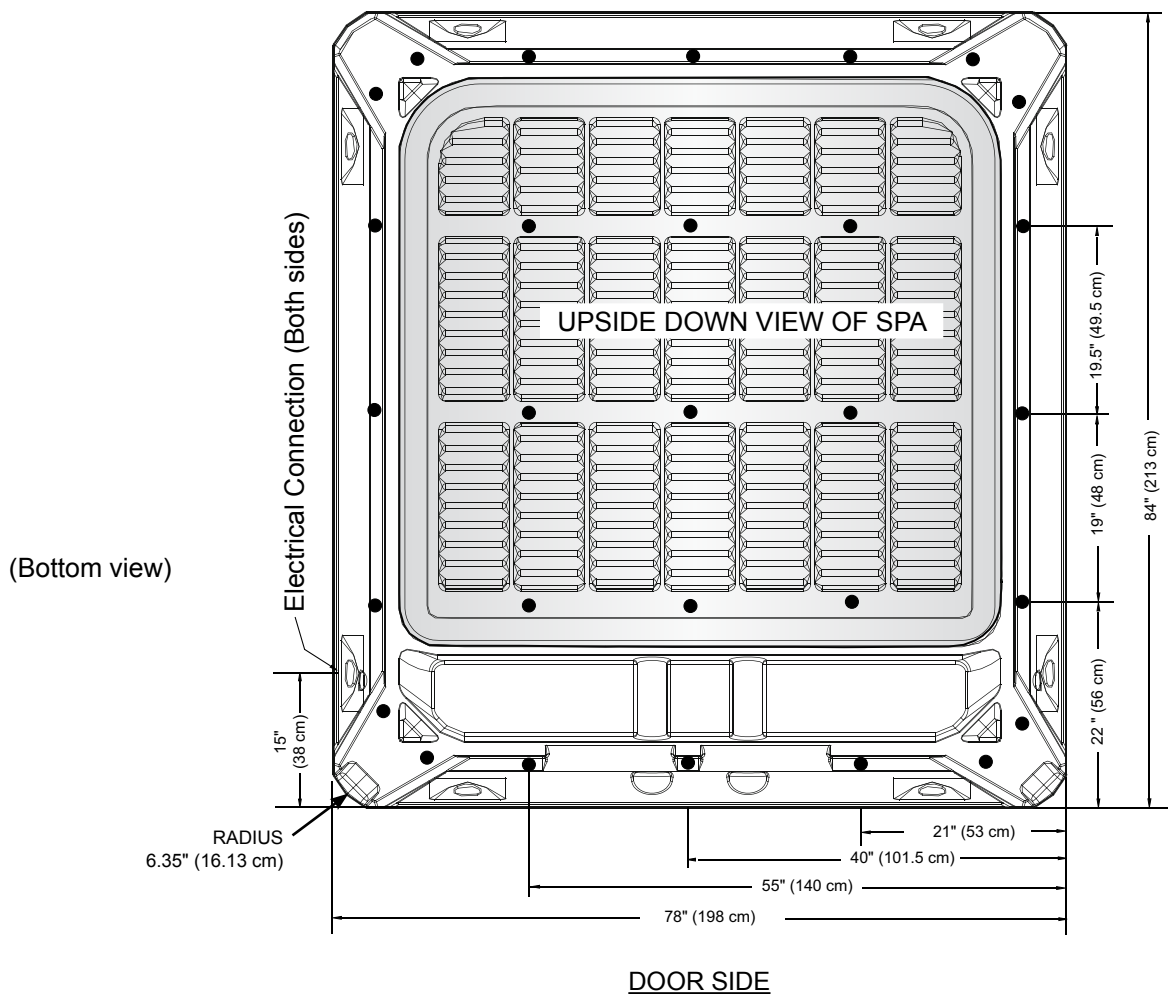
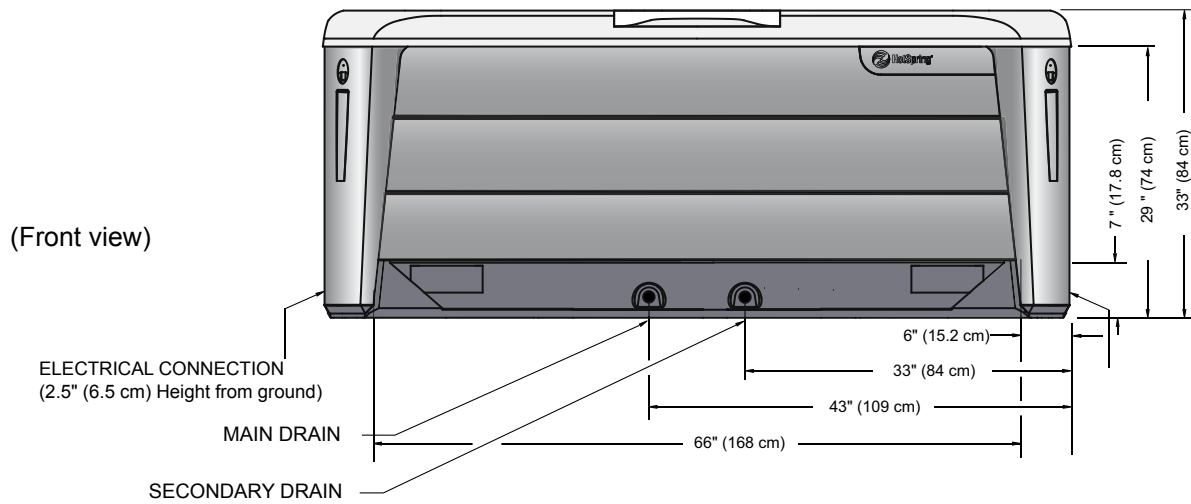

● **IMPORTANT:** The PRODIGY has 29 leveling points (place shims at illustrated locations)

JETSETTER LX & JETSETTER

Dimensions

NOTE: All dimensions are approximate; measure your spa before making critical design or pathway decisions.

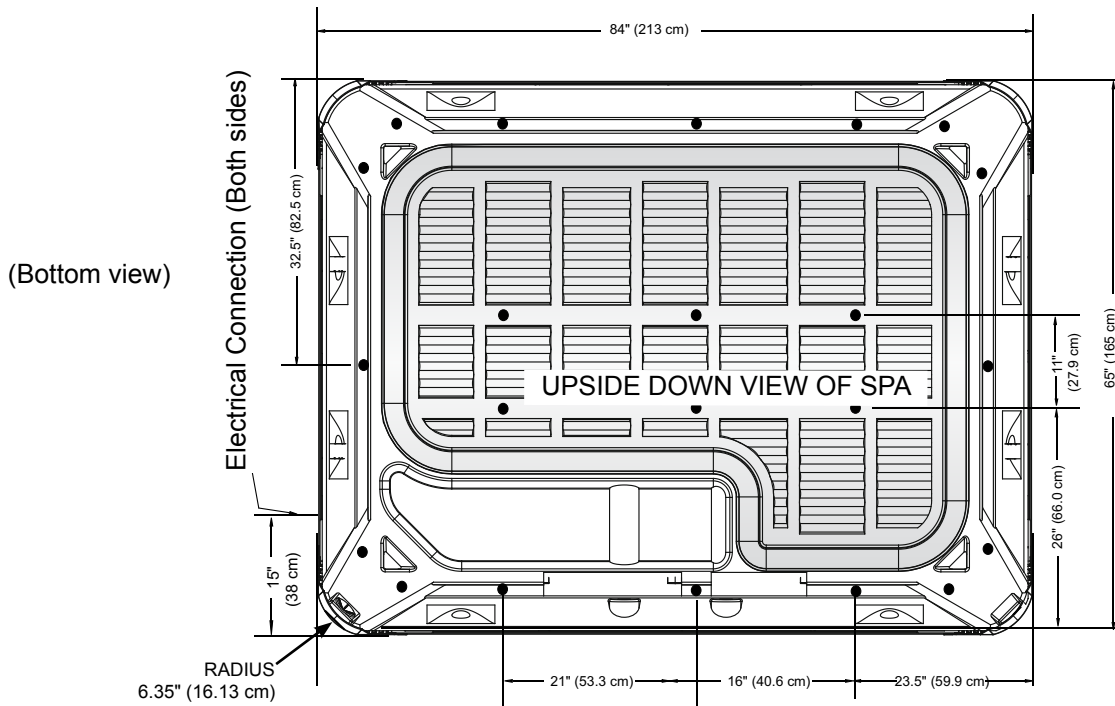
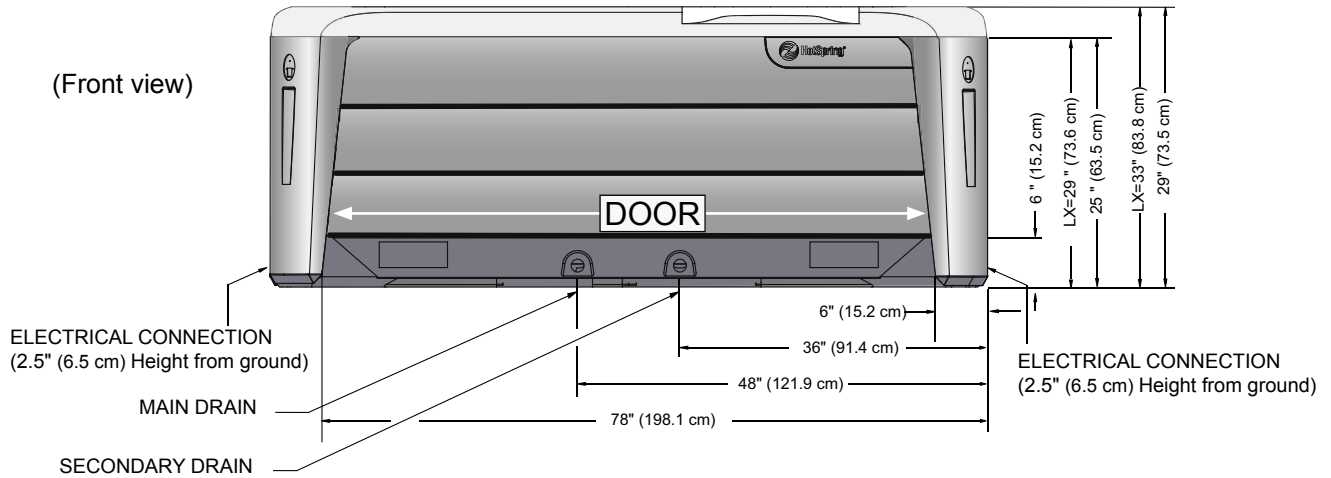

DOOR SIDE

● **IMPORTANT:** The JETSETTER has 22 leveling points ● (place shims at illustrated locations)

SERVICE INFORMATION

GENERAL INFORMATION

Your **HOT SPRING** spa has been designed to provide years of trouble-free use. As with any appliance, problems may occasionally occur that require the expertise of a qualified service person. Though such simple repairs as resetting a RCD switch or breaker, or resetting a high limit thermostat may not require a service call, they may indicate that a more serious condition exists. These conditions may require an experienced service person. Before calling for service, please refer to the Troubleshooting Guide. Always retain your original sales receipt for future reference.

RCD AND HIGH LIMIT THERMOSTAT

If your spa fails to operate at any time, first check the power supply to the spa.

Check each of the RCD breakers in the subpanel. If a RCD has tripped, reset it. If it will not reset, this may be an indication of a ground fault (short circuit) within the electrical components. Contact an Authorized Service Technician for a complete diagnosis.

If upon checking the RCD you find that they have not tripped, check the house breaker panel and ensure the main breaker for the electrical circuit supplying the spa has not tripped. If it has, this is an indication that the circuit was either overloaded or a ground fault exists between the breaker panel and the spa receptacle or subpanel. Contact a qualified electrician.

If upon checking the main house breaker and spa RCD you find no failures, check the high limit thermostat. To check it, simply turn off power to the spa for 30 seconds. This will automatically reset the high limit thermostat if it has tripped. If the spa energizes once you turn the power back on, this indicates reduced water flow through the heating system. Tripping of the high limit thermostat is normally a result of one or a combination of these problems: 1) clogged filter cartridge(s), 2) blockage within the system plumbing, 3) a non-functioning heater circulation pump, 4) power was not disconnected from the spa before it was drained, 5) an air lock in the plumbing lines. The Power Indicator on the front of the spa's control panel will also be blinking if the high limit thermostat circuit has tripped.

If the spa does not function after tripping and resetting the RCD or resetting the high limit thermostat, then the problem should be referred to an Authorized Service Technician. Refer to the Heater section if the spa operates but does not heat, or refer to the Troubleshooting Guide for additional service information.

NO-FAULT HEATER AND INTEGRATED PRESSURE SWITCH

WATKINS WELLNESS unconditionally warrants the **NO-FAULT** heater against any failure that would require replacement. This warranty's duration is equal to the time period identified in the Component Warranty. This warranty defines unconditional as warranty coverage without exception provided that the component has failed to operate properly within the spa's system. This means that conditions that would normally invalidate the limited warranty, such as water chemistry damage, do not apply to the **NO-FAULT** heater.

It is important to note that the **NO-FAULT** heater is protected by both the heater high limit thermostat circuit and the integrated pressure switch. The causes of heater high limit tripping are discussed in the previous section.

If the spa is not heating, the red and green lights are blinking, but the pump and light are operating, then the pressure switch may be open. Opening of the pressure switch is normally a result of one or a combination of these problems:

1. A clogged filter cartridge
2. Blockage within the system plumbing
3. Power was not disconnected to the spa before it was drained
4. An air lock in the plumbing lines

Once the problem has been identified and corrected the pressure switch will close which will energize the heater.

SILENT FLO CIRCULATION PUMP AND CIRCULATION PUMP THERMAL CUT-OFF

The **HOT SPRING SILENT FLO** 5000 circulation pump is a dedicated, water cooled, energy efficient, quiet pump that provides continuous filtration for the spa. Since the **SILENT FLO** 5000 pump is water cooled, it is equipped with a thermal cut-off to prevent the pump from being damaged by running hot when water is not present.

Reset the circulation pump's thermal cut-off by disconnecting power to the spa and allowing the pump to cool.

Tripping of the thermal cut-off is normally the result of one or a combination of these problems: 1) clogged filter cartridge(s), 2) blockage within the system plumbing, 3) power was not disconnected to the spa before it was drained, or 4) an air lock in the plumbing lines. Once the problem has been identified and corrected the pump thermal cut-off will be able to be reset which will allow it to operate normally.

MISCELLANEOUS SERVICE INFORMATION

The control and high-limit thermostats are equipped with electronic sensors that are connected to the spa's plumbing. Never cut or kink the wires that connect the sensors to the thermostats within the control box.

The jet pump is equipped with a thermal overload cutoff switch that is designed to protect the pump from overheating. If the pump shuts itself off in an older spa, it could indicate failure of the pump motor bearings. If the pump shuts itself off in a new spa, it is usually the result of one or a combination of the following factors:

- Thermal overload: Although mass-produced, not all thermal overload cutoffs are exactly the same. Some are more sensitive than others and will shut the pump off at lower temperatures.
- High temperature: All **HOT SPRING** spa models are equipped with a jet pump shroud that vents the heat generated by the pump motor to the outside of the equipment compartment, and back into the spa water. If the vent is blocked by masonry, grass or debris, overheating of the jet pump may occur. Once the pump motor has cooled sufficiently and any blockage has been removed from the vent opening, the jet pump can be restarted.
- Friction: Sometimes the moving parts of a new pump are tight enough to cause heat build-up due to friction. After a normal break-in period, the pump will run cooler.
- Improper wiring: If the spa is connected with an extension cord, and/or the house wiring is undersized, the pump may starve for voltage and therefore may draw more amperage and generate excessive heat.

- If the pump is shutting down due to excessive heat, make sure the equipment compartment has adequate ventilation. The air gap at the bottom must not be blocked. Should your jet pump continue to shut off after short periods of use, contact a qualified service technician.

ACTS INVALIDATING WARRANTY

The limited warranty is void if the **HOT SPRING** spa has been improperly installed, subjected to alteration, misused, or abused, or if any repairs on the spa are attempted by anyone other than an authorized representative of **WATKINS WELLNESS**. Alteration shall include any component or plumbing change, electrical conversion, or the addition of any non-approved sanitation or water purification device, or heating system which contributes to component or unit failure or unsafe operating system. Misuse and abuse shall include: Any operation of the spa other than in accordance with **WATKINS WELLNESS** printed instructions, or use of the spa in an application for which it is not designed. Specifically: Use of the spa in a non-residential application; damage caused by operation* of the spa outside the specified voltage requirements (240V ±10%) or operation of the spa at water temperatures outside the range of 1.7°C (35°F) and 49°C (120 °F); damage caused by voltage spikes or “brown out” conditions; damage caused by dirty, clogged or calcified filter cartridges (see Spa Care and Maintenance instructions in this Owner’s Manual); damage to the spa surface caused by the use of tri-chloro chlorine, BCDMH, chemical tablets in a floater, acid, or any other spa sanitizing chemicals or spa surface cleaners which are not recommended by **WATKINS WELLNESS**; damage caused by allowing undissolved spa sanitizing chemicals to lie on the spa surface (no spa surface material can withstand this kind of abuse); damage to components (excluding the **NO-FAULT** heater) or spa surface caused by improper pH balance or other improper water chemistry maintenance; and damage to the spa surface caused by leaving the spa uncovered while empty of water and in direct exposure to sunlight (this may cause solar heating distress) are considered abuses and may invalidate this warranty.

*Operation of the spa does not mean “use” of the spa! **WATKINS**

WELLNESS does not recommend using the spa if the water temperature is above or below the spa’s control panel temperature range.

The filter lid on the spa is not designed to support heavy weight loads and should not be used as a seat. In extreme cases the lid could crack and break. This occurrence is considered abuse and is not covered under this warranty.

Acts of nature, and damage caused by animals, rodents, and insects are considered abuses and are not covered under this warranty.

DISCLAIMERS

WATKINS WELLNESS shall not be liable for loss of use of the **HOT SPRING** spa or other incidental, consequential, special, indirect, or punitive costs, expenses or damages, which may include but are not limited to the removal of a permanent deck or other custom fixture or the necessity for crane removal. Any implied warranty shall have a duration equal to the duration of the applicable limited warranty stated above. Some states do not allow limitations on how long an implied warranty lasts. Under no circumstances shall **WATKINS WELLNESS** or any of its representatives be held liable for injury to any person or damage to any property, however arising.

Some states do not allow the exclusion or limitation of incidental or consequential damages, so the above limitations may not apply to you.

CUSTOMER SERVICE

If you have any questions about any aspect of your **HOT SPRING** spa set-up, operation or maintenance that have not been answered by this manual, consult your **HOT SPRING** dealer.

TROUBLESHOOTING

Should you experience any problem whatsoever, do not hesitate to contact your authorized **HOT SPRING** dealer. On the following page are some tips to help you to diagnose and rectify some more common sources of trouble, if you choose to do so.

SPA WATER MAINTENANCE TROUBLESHOOTING GUIDE

Problem	Probable causes	Solutions
Cloudy Water	<ul style="list-style-type: none"> • Dirty filters • Excessive oils / organic matter • Improper sanitization • Suspended particles / organic matter • Overused or old water 	<ul style="list-style-type: none"> • Clean filters • Shock spa with sanitizer • Add sanitizer • Adjust pH and/or alkalinity to recommended range • Run jet pump(s) and clean filters • Drain and refill the spa
Water Odor	<ul style="list-style-type: none"> • Excessive organics in water • Improper sanitization • Low pH 	<ul style="list-style-type: none"> • Shock spa with sanitizer • Add sanitizer • Adjust pH to recommended range
Chlorine Odor	<ul style="list-style-type: none"> • Chloramine level too high • Low pH 	<ul style="list-style-type: none"> • Shock spa with sanitizer • Adjust pH to recommended range
Musty Odor	<ul style="list-style-type: none"> • Bacteria or algae growth 	<ul style="list-style-type: none"> • Shock spa with sanitizer—if problem is visible or persistent, drain, clean and refill the spa
Organic buildup/scum ring around spa	<ul style="list-style-type: none"> • Build-up of oils and dirt 	<ul style="list-style-type: none"> • Wipe off scum with clean rag – if severe, drain the spa, use a spa surface and tile cleaner to remove the scum, and refill the spa
Algae Growth	<ul style="list-style-type: none"> • High pH • Low sanitizer level 	<ul style="list-style-type: none"> • Shock spa with sanitizer and adjust pH • Shock spa with sanitizer and maintain sanitizer level
Eye Irritation	<ul style="list-style-type: none"> • Low pH • Low sanitizer level 	<ul style="list-style-type: none"> • Adjust pH • Shock spa with sanitizer and maintain sanitizer level
Skin Irritation/Rash	<ul style="list-style-type: none"> • Unsanitary water • Free chlorine level above 5 ppm 	<ul style="list-style-type: none"> • Shock spa with sanitizer and maintain sanitizer level • Allow free chlorine level to drop below 5 ppm before spa use
Stains	<ul style="list-style-type: none"> • Total alkalinity and/or pH too low • High iron or copper in source water 	<ul style="list-style-type: none"> • Adjust total alkalinity and/or pH • Use a metal deposit inhibitor
Scale	<ul style="list-style-type: none"> • High calcium content in water – total alkalinity and pH too high 	<ul style="list-style-type: none"> • Adjust total alkalinity and pH – if scale requires removal, drain the spa, scrub off the scale, refill the spa and balance the water

GENERAL OPERATION TROUBLESHOOTING GUIDE

Problem	Probable causes	Solutions
Entire spa is inoperative	<ul style="list-style-type: none"> Power failure RCD tripped Heater high-limit thermostat tripped Spa lock activated 	<ul style="list-style-type: none"> Check power source Reset RCD; call for service if it will not reset Disconnect power for at least thirty seconds to reset heater high limit. If it will not reset, check for clogged filters. If tripping continues, call for service. Deactivate spa lock
Spa does not heat; jets and light operate (Green logo "Ready", and Blue logo "Power" indicators are blinking)	<ul style="list-style-type: none"> Integrated pressure switch open Circulation pump thermal cut-off tripped 	<ul style="list-style-type: none"> Check for clogged filters. Integrated pressure switch will reset when the flow of water through the heater has been restored. Call for service if the heater trips frequently. Check for clogged filters or air locks in plumbing. Disconnect power to the spa, allow circulation pump to cool. Circulation pump thermal cut-off will reset when pump has cooled and power is reapplied. Call for service if circulation pump thermal cut-off trips frequently.
Jets weak or surging	<ul style="list-style-type: none"> Spa water level too low Filters clogged COMFORT CONTROL lever closed 	<ul style="list-style-type: none"> Add water Clean filters Open COMFORT CONTROL lever
Light inoperative	<ul style="list-style-type: none"> Spa lock activated Light wiring or assembly is faulty 	<ul style="list-style-type: none"> Deactivate spa lock Replace light assembly
MOTO-MASSAGE DX jet inoperative or erratic	<ul style="list-style-type: none"> COMFORT CONTROL valves closed Filters clogged 	<ul style="list-style-type: none"> Open COMFORT CONTROL levers Clean filters
Blue Logo "Power" indicator blinking	<ul style="list-style-type: none"> Heater high-limit thermostat tripped 	<ul style="list-style-type: none"> Disconnect power for at least thirty seconds to reset heater high limit. If it will not reset, check for clogged filters. If tripping continues, call for service.
Green Logo "Ready" indicator blinking	<ul style="list-style-type: none"> Temperature sensor problem 	<ul style="list-style-type: none"> Disconnect power for at least thirty seconds. If blinking continues, call for service.
Green Logo "Ready" indicator flashing On 1 second and Off 3 seconds	<ul style="list-style-type: none"> Salt system issue 	<p>Go to the Salt System menu on the control panel. Based on the Error Code displayed, follow the instructions below:</p> <ul style="list-style-type: none"> Error Code 5 <ol style="list-style-type: none"> Using a FreshWater Salt test strip, verify that salt levels are at 1750 ppm. Add salt, per salt system instructions as necessary Power down the spa, remove salt system housing cap and verify that a salt cartridge is installed in the housing Contact your local Dealer if neither a. or b. resolves the problem Error Code 4 <ol style="list-style-type: none"> Power down the spa, remove the salt system housing cap and remove the salt system cartridge. Inspect the cartridge for damage. If damage is found the cartridge should be replaced Using a FreshWater Salt test strip, verify the salt level. If the salt level is above 2500 ppm this may be the problem. If the salt level is above 2500 you will now need to determine how much above 2500 ppm the salt level is by following the steps below: <ol style="list-style-type: none"> Use a clean container and fill with 0.25 liter (8 ounces) of water from the spa Remove 0.125 liter (4 ounces) of the spa water from the container Then add 0.125 liter (4 ounces) of water from your household tap and mix to combine Using a new FreshWater Salt test strip, confirm the salt level of this new mixture of spa and tap water <ol style="list-style-type: none"> If the salt level is still at or above 2500 ppm, power down the spa, drain and refill the spa with new water and follow the salt system start up instructions ensuring that salt level is at 1750 ppm If the salt level is below 2500 ppm, the amount of salt in the spa is not causing the error – contact your local Dealer for assistance Contact your local Dealer if neither a. or b. resolves the problem
Touchscreen is on but becomes inoperable	<ul style="list-style-type: none"> Remote Control too far away from spa Communication between remote control and control system has been interrupted 	<ul style="list-style-type: none"> Move Remote Control closer to spa Press Jets button on DOCK Press and hold the touchscreen in a blank area until it turns black, this will reset the control panel.
Touchscreen is black (off)	<ul style="list-style-type: none"> Power to spa is off Battery needs to be recharged Battery is in Shut-Down mode Battery is not recharging 	<ul style="list-style-type: none"> Turn power to spa on Place remote control back into Docking tray Press touchscreen and wait for 40 seconds Contact your authorized HOT SPRING Dealer
Remote has intermittent response when inside the 9 m (30') usable range	<ul style="list-style-type: none"> Signal Interference from outside source 	<ul style="list-style-type: none"> Change channel on remote by pressing the Lights button on the DOCK until dock buttons flash to display a change channel screen on the remote. Press UP or DOWN to change the channel followed by OK to set
Black Screen on touchscreen continuously reads "Searching for spa"	<ul style="list-style-type: none"> Remote not paired 	<ul style="list-style-type: none"> Press Jets button on DOCK until dock buttons flash, press and hold screen until Pairing Yes/ No is displayed then press Yes to pair

DOOR PANEL REMOVAL

Use the following instruction to remove the front door panel below the docking station.

When replacing the door, reverse the order making sure the Logo is seated in the top right corner of the spa as illustrated in Step 1.



1 Locate the 3 clips A, B & C

2 Start with clip A and perform the following instructions, then repeat in order for steps B and C

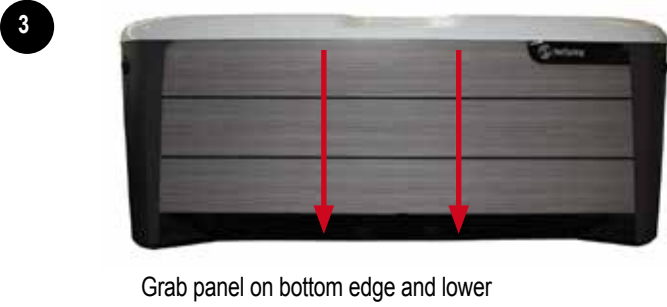
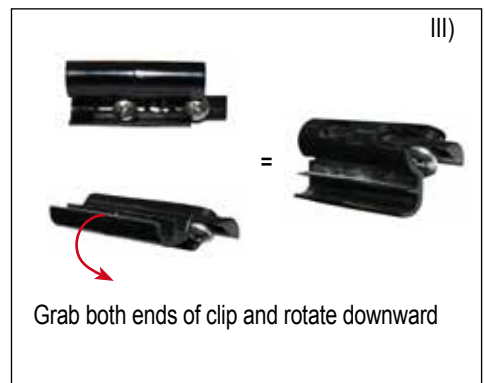
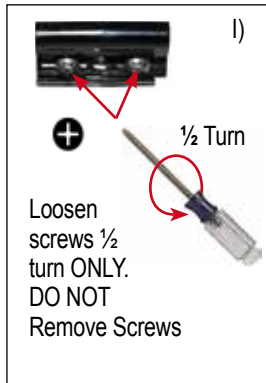

Disconnect logo light wire from back side of door panel

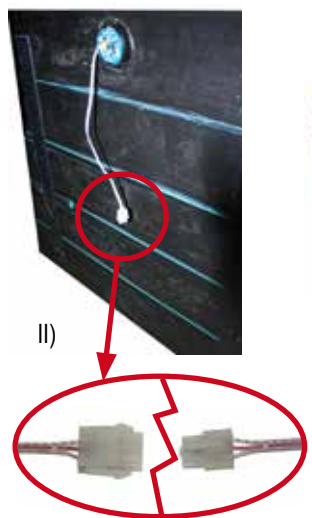
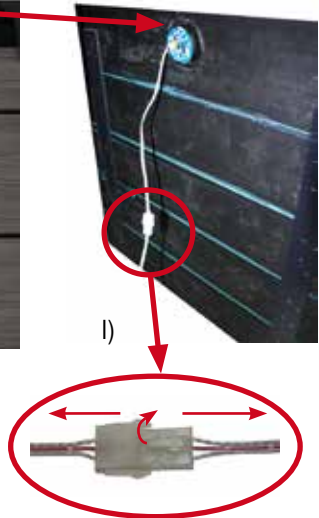

Remove panel from spa and place in cool shaded place

SPA SPECIFICATIONS

Spa Model	Footprint Dimension	Height	Effective Filter Area	Heater (Watts)	Water Capacity	Dry Weight	Filled Weight*	Dead Weight*	Electrical Requirements
GRANDEE (Model GGNE) Seats 7 Adults	2.54 m x 2.31 m	97 cm 38"	30 m ^{2**} 325 ft ^{2**}	1,500	1,700 liters 450 gallons	425 kg 940 lbs	2,685 kg 5,920 lbs	565 kg/m ² 115 lbs/ft ²	230 volt, 20 amp ¹ Single phase RCD ² protected circuit
ENVOY (Model KKNE) Seats 5 Adults	2.36 m x 2.31 m	97 cm 38"	30 m ^{2**} 325 ft ^{2**}	1,500	1,475 liters 390 gallons	375 kg 830 lbs	2,250 kg 4,960 lbs	535 kg/m ² 110 lbs/ft ²	230 volt, 20 amp ¹ Single phase RCD ² protected circuit
VANGUARD (Model VVNE) Seats 6 Adults	2.21 m x 2.21 m	91 cm 36"	30 m ^{2**} 325 ft ^{2**}	1,500	1,275 liters 335 gallons	315 kg 695 lbs	2,070 kg 4,540 lbs	565 kg/m ² 115 lbs/ft ²	230 volt, 20 amp ¹ Single phase RCD ² protected circuit
ARIA (Model ARNE) Seats 5 Adults	2.21 m x 2.21 m	91 cm 36"	30 m ^{2**} 325 ft ^{2**}	1,500	1,225 liters 325 gallons	315 kg 695 lbs	1,940 kg 4,280 lbs	535 kg/m ² 110 lbs/ft ²	230 volt, 20 amp ¹ Single phase RCD ² protected circuit
SOVEREIGN (Model IINE) Seats 6 Adults	2.03 m x 2.36 m	84 cm 33"	18 m ^{2**} 195 ft ^{2**}	1,500	1,200 liters 315 gallons	275 kg 610 lbs	1,945 kg 4,290 lbs	530 kg/m ² 110 lbs/ft ²	230 volt, 16 amp ¹ Single phase GFCI ² protected circuit
TRIUMPH (Model TRHNE) Seats 4 Adults	2.36 m x 1.88 m	84 cm 33"	18 m ^{2**} 195 ft ^{2**}	1,500	1,275 liters 340 gallons	240 kg 525 lbs	1,840 kg 4,060 lbs	525 kg/m ² 110 lbs/ft ²	230 volt, 16 amp ¹ Single phase GFCI ² protected circuit
PRODIGY (Model HNE) Seats 5 Adults	1.98 m x 2.13 m	84 cm 33"	18 m ^{2**} 195 ft ^{2**}	1,500	1,100 liters 290 gallons	245 kg 540 lbs	1,740 kg 3,835 lbs	550 kg/m ² 110 lbs/ft ²	230 volt, 16 amp ¹ Single phase GFCI ² protected circuit
JETSETTER LX (Model JTNE) Seats 3 Adults	2.13 m x 1.65 m	84 cm 33"	18 m ^{2**} 195 ft ^{2**}	1,500	800 liters 210 gallons	220 kg 480 lbs	1,250 kg 2,755 lbs	460 kg/m ² 95 lbs/ft ²	230 volt, 16 amp ¹ Single phase RCD ² protected circuit
JETSETTER (Model JJNE) Seats 3 Adults	2.13 m x 1.65 m	74 cm 74"	18 m ^{2**} 195 ft ^{2**}	1,500	750 liters 200 gallons	205 kg 455 lbs	1,200 kg 2,650 lbs	440 kg/m ² 90 lbs/ft ²	230 volt, 16 amp ¹ Single phase RCD ² protected circuit

⚠ WARNING: WATKINS WELLNESS suggests a structural engineer or contractor be consulted before the spa is placed on an elevated deck.

1. The current rating (Amps) may vary, depending on the country. Contact your **HOT SPRING** dealer for specific information regarding your spa model.
2. The RCD (Residual Current Device) may also be referred to as an ELCB (Earth Leakage Circuit Breaker).

* **NOTE:** The "Filled Weight" and "Dead Weight" of the spa includes the weight of the occupants (assuming an average occupant weight of 80 kg).

** Effective filter area is based on 0.6 m² (6.5 ft²) actual area per filter (3 or 5 filters used) with 10 times effectivity rating.



This manual contains installation, operating, maintenance and service information for the following 2021 **HOT SPRING** spa models:

MODELS	EFFECTIVE DATE
GRANDEE (MODEL GGNE)	10/20
ENVOY (MODEL KKNE)	10/20
VANGUARD (MODEL VVNE)	10/20
ARIA (MODEL ARNE)	10/20
SOVEREIGN (M ODEL IINE)	10/20
TRIUMPH (MODEL TRHNE)	10/20
PRODIGY (MODEL HNE)	10/20
JETSETTER LX (MODEL JTNE)	10/20
JETSETTER (MODEL JJNE)	10/20

©2020 All Rights Reserved. Hot Spring, and Highlife are trademarks of WATKINS WELLNESS, registered in the U.S., Canada, CTM and other countries. BaquaSpa is a trademark of Arch UK Biocides Limited. Brominating Concentrate is a trademark of Bio-Lab Inc.



WatkinsWellness[®]

Feel good. Live well.

Vista, California USA

